



TIEMME

SCIROCCO

Art. 2310

Valvole a sfera PN 30 a passaggio totale con estremità filettate femmina/femmina o maschio/femmina UNI ISO 228.

Disponibile con leve piatte o a farfalla, in acciaio o alluminio, verniciate o plastificate.

Full bore ball valves PN 30 with female/female or male/female threaded ends UNI 228.

Available with flat or "T" handles made in steel or aluminium, painted or plasticized.

Si adatta ad ogni tipo di impianto idraulico domestico e commerciale, applicazioni industriali ed agricole, impianti di riscaldamento ed igienico sanitari, aria compressa, olii vari, prodotti petroliferi, generalmente con ogni fluido non corrosivo.

Suitable for domestic and commercial plumbing, industrial and agricultural applications, heating and sanitary systems pneumatic systems, oils, generally with every non aggressive fluid.



Per la gamma completa vedere il catalogo / For complete range see catalogue



N° 04 ACC LY 052

Certificazioni / Certifications



Caratteristiche Tecniche

Temperatura max di esercizio: 120 °C
 Temperatura min di esercizio: - 20°C (*)
 Pressione max di esercizio: Vedere tabella dimensioni
 Filettature: femmina ISO 228
 maschio ISO 228

Technical Features

Maximum temperature: 120°C
 Minimum temperature: - 20°C (*)
 Maximum operating pressure: See dimensional table
 Threads: female ISO 228
 male ISO 228

Descrizione

Corpo
 Sfera
 Stelo
 O-rings
 Guarnizioni laterali
 Leva
 Leva piatta
 Leva e farfalla
 Dado

Materiale

Ottone CW617N - EN12165
 Ottone CW617N - EN12164
 Ottone CW617N - EN12164
 Gomma nitrilica NBR
 P.T.F.E.
 Acciaio Fe37
 Acciaio Fe37
 Alluminio
 Acciaio

Trattamento

Nichelato
 Cromato
 Nichelato
 -
 -
 Verniciato
 Zincato - plastificato
 Verniciato
 Zincato

Description

Body
 Ball
 Stem
 O-rings
 Side washers
 Handle
 Flat handle
 Handle & Butterfly
 Nut

Material

CW617N-EN12165 brass
 CW617N-EN12164 brass
 CW617N-EN12164 brass
 Nitrile Rubber NBR
 P.T.F.E.
 Steel Fe37
 Steel Fe37
 Aluminium
 Steel

Treatment

Nickel plated
 Chromium plated
 Nickel plated
 -
 -
 Painted
 Zinc plated - plasticized
 Painted
 Zinc plated

(*) purché il fluido rimanga in fase liquida / provided that the fluid remains in the liquid phase

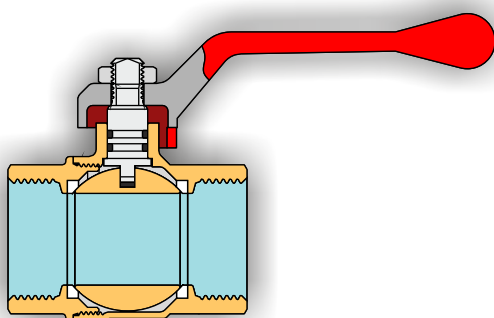

TIEMME Raccorderie S.p.A. si riserva di apportare modifiche in qualsiasi momento senza preavviso.
 TIEMME Raccorderie S.p.A. reserves the right to modify contents in any time without prior advise.
 TIEMME Raccorderie S.p.A. si riserva di apportare modifiche in qualsiasi momento senza preavviso.
 TIEMME Raccorderie S.p.A. reserves the right to modify contents in any time without prior advise.
 is forbidden any reproduction unless under TIEMME autorization





TIEMME

SCIROCCO

Art. 2310



Tabella dimensioni Sizes table

Size	1/4"	3/8"	1/2"	3/4"	1"	1"1/4	1"1/2	2"	2"1/2	3"	4"
Ø (DN)	10	10	15	20	25	32	40	50	60	74	94
A	85	85	85	85	100	140	140	140	240	240	240
A 2320	50	50	50	50	65	---	---	---	---	---	---
A 2330	85	85	85	85	113	141	141	141	240	240	240
B	46	46	51,5	54,5	61,5	73	79	91,5	118	128	142
ØC	23	23	30	37	45	55	68	84	103	124	152
E	10	12	13,5	14,5	14	15	16	17,5	21,5	23,5	27
L	42	47	53	60,5	65	77,5	89	103	130	149	178
Em	11	11,5	10	12	13	14	15	16,5	---	---	---
Lm/f	43	57	56,5	64	70	85,5	96,5	114	---	---	---
Lm/m	---	56	53,5	59,5	69	84	96,5	114	---	---	---
PN	30	30	30	30	30	25	25	25	16	16	16

Diagramma pressione / temperatura Pressure / temperature diagram

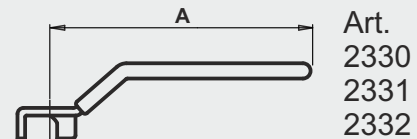
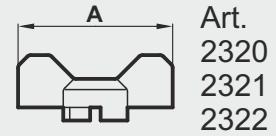
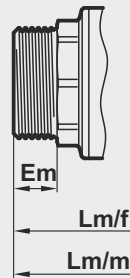
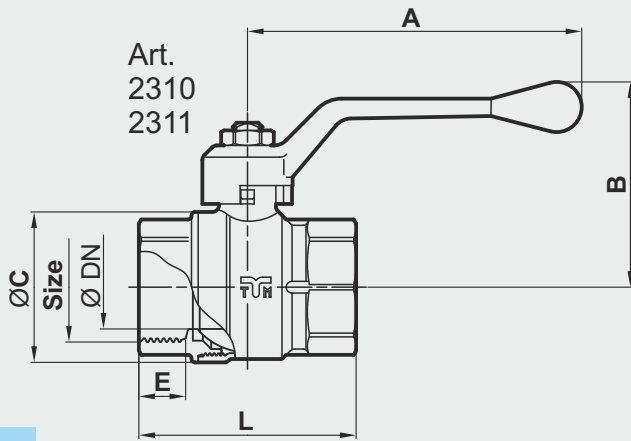

Diagramma portata/perdita di carico Flow/pressure drop diagram



TIEMME Raccorderie S.p.A. si riserva di apportare modifiche in qualsiasi momento senza preavviso.
 TIEMME Raccorderie S.p.A. reserves the right to modify contents in any time without prior advise.
 È vietata qualsiasi forma di riproduzione, se non autorizzata.
 is forbidden any reproduction unless under TIEMME authorization

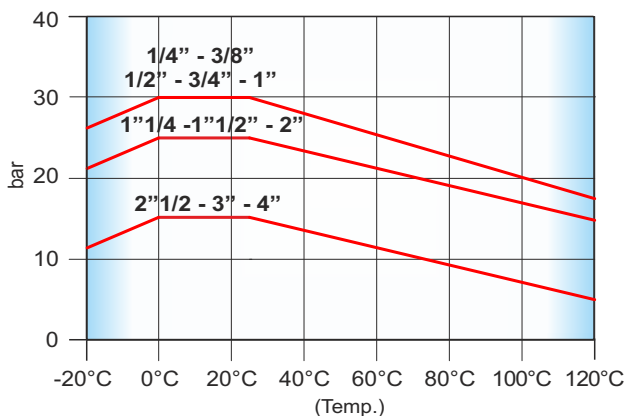
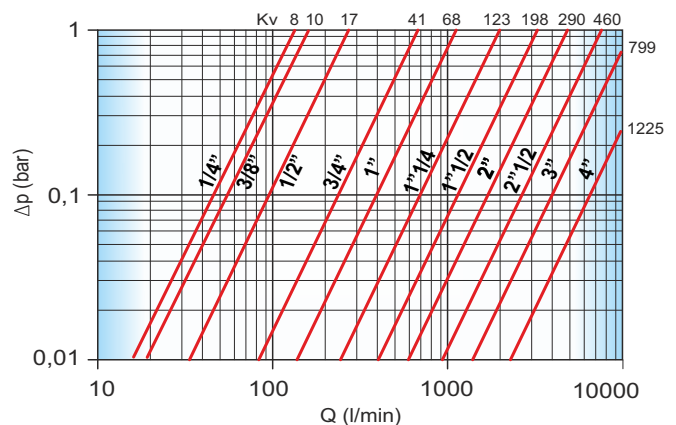

TIEMME Raccorderie S.p.A.
 Via Cavallera 6/A (Loc. Barco) - 25045 Castegnato (Bs) - Italy
 Tel +39 030 2142211 R.A. - Fax +39 030 2142206
 info@tiemme.com - www.tiemme.com

©TIEMME Raccorderie S.p.A. 2310 Rev. E 09-11





TIEMME

SCIROCCO

Art. 2310

Istruzioni per l'installazione Installation instructions

Le valvole possono essere montate in qualsiasi posizione (orizzontale, verticale, ...) purché siano visibili, accessibili e le operazioni di manovra possano essere facilmente eseguite fino alla completa chiusura e/o apertura.

Salvo diversamente indicato la chiusura della valvola avviene in senso orario e l'apertura in senso anti-orario.

La direzione di montaggio della valvola rispetto al flusso del circuito è indifferente se non diversamente specificato con l'apposizione di specifiche marcature (generalmente frecce) sul corpo valvola.

L'impianto deve essere progettato e realizzato in modo tale da evitare sollecitazioni tali da danneggiare la valvola ed impedirne la corretta tenuta ed il buon funzionamento.

Le operazioni di collegamento tra la valvola e la raccorderia di connessione all'impianto devono essere eseguite con attrezzature idonee. La coppia di serraggio deve essere tale da garantire la corretta tenuta senza arrecare danneggiamenti alla valvola od ai raccordi.

Ad installazione completata è necessario eseguire la verifica delle tenute secondo quanto specificato dalle norme tecniche e/o dalle leggi vigenti nel paese di utilizzo.

La valvola non va tenuta in posizione intermedia per lunghi periodi onde evitare danneggiamenti degli organi di tenuta della valvola stessa.

In caso di lunga inattività della valvola è possibile che la manovrabilità risulti difficile pertanto si rende necessario l'utilizzo di "leve lunghe" per facilitarne l'apertura e/o chiusura.

Per mantenere la valvola ed i relativi organi di tenuta in buone condizioni è suggerito installare un filtro per la raccolta di eventuali impurità a monte della valvola.

Tiemme Raccorderie SpA declina ogni responsabilità in caso di guasti e/o incidenti qualora l'installazione non sia stata realizzata in conformità con le norme tecniche e scientifiche in vigore ed in conformità a manuali, cataloghi e/o relative disposizioni tecniche indicate da Tiemme Raccorderie SpA.

Per qualsiasi ulteriore informazione rivolgersi ai rivenditori autorizzati o direttamente a TIEMME SpA.

The valves can be installed in any position (horizontal, vertical, ...) provided that shall be placed in visible and accessible position and the open/close operations shall be easily and completely done.

Otherwise stated to close the valve the handle shall be turned clockwise, counterclockwise to open it.

Otherwise stated by specific marks on the valve body (arrows,...) there is no valve flow direction.

The system shall be designed and realised in order to avoid any stress that could damage the valve and could compromise the sealing and the correct working of the valve.

All installation operations shall be done using properly tooling. The tightenings shall be such as to guarantee the sealing but without make any damage to the valve or fittings.

Once the installation have been completed is necessary to verify the sealings according to technical specifications and/or what required by the country of installation.

The valve should not be kept in intermediate position for a long period of time in order to avoid any damages of the valve sealings.

If the valve have not been used for a long period of time it may be difficult to operate therefore it will be necessary to use a "long lever".

To kept the valve and sealings in good conditions it is suggested to place a filter upstream in order to stop impurity.

Tiemme Raccorderie SpA decline any responsibility in case of damages and/or accidents when the installation is not done in conformity with technical and scientific rules in force and in conformity with manuals, catalogues and/or technical documentation written by Tiemme Raccorderie SpA.

For any further information please refer to your local dealer or directly to TIEMME S.p.A.



TIEMME Raccorderie S.p.A.
Via Cavallera 6/A (Loc. Barco) - 25045 Castegnato (Bs) - Italy
Tel +39 030 2142211 R.A. - Fax +39 030 2142206
info@tiemme.com - www.tiemme.com
©TIEMME Raccorderie S.p.A. 2310 Rev. E 09-11

