



TECHNICAL CATALOGUE

# STRAINERS



1/4" - 2": 500µm  
2"1/2 - 4": 800µm

## > THE COMPANY

ITAP SpA, founded in Lumezzane (Brescia) in 1972, is currently one of the leading production companies in Italy of **valves, fittings and distribution manifolds** for plumbing and heating systems.

Thanks to fully automated production processes, with 85 transfer machines and 55 assembly lines, we are able to produce 400,000 pieces per day.

Our innate pursuit for innovation and observance of technical regulations is supported by the company certification ISO 9001. The company has always considered its focus on quality as the main tool to obtain significant business results: today ITAP SpA is proud to offer products bearing the approval of numerous international certifying bodies.

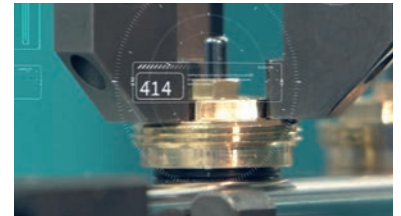

> ITAP products have obtained approvals by more than 30 certification bodies from all over the world.





# STRAINERS

## 192 Y strainer

Suitable for domestic water services, heating and air-conditioning plants, compressed air systems.

Y STRAINER

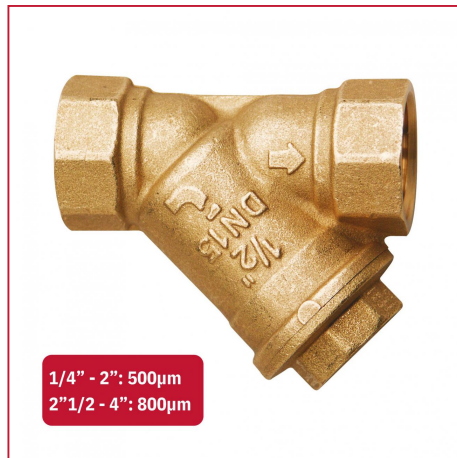

1/4" - 2": 500µm  
2"1/2 - 4": 800µm

SIZE	PRESSURE	CODE	PACKING
1/4" (DN 8)	20bar/290psi	1920014	20/140
3/8" (DN 10)	20bar/290psi	1920038	20/140
1/2" (DN 15)	20bar/290psi	1920012	20/140
3/4" (DN 20)	20bar/290psi	1920034	10/70
1" (DN 25)	20bar/290psi	1920100	8/48
1"1/4 (DN 32)	20bar/290psi	1920114	5/30
1"1/2 (DN 40)	20bar/290psi	1920112	2/18
2" (DN 50)	20bar/290psi	1920200	2/10
2"1/2 (DN 65)	16bar/232psi	1920212	1/7
3" (DN 80)	16bar/232psi	1920300	1/6
4" (DN 100)	16bar/232psi	1920400	1/2

### CERTIFICATIONS



### TECHNICAL SPECIFICATIONS

Female/female threads and inspection plug.

Body in brass.

Minimum and maximum working temperatures: -20°C, 110°C in absence of steam.

Threads: ISO 228 (equivalent to DIN EN ISO 228 and BS EN ISO 228).

'Filtration degree: 1/4" through 2": 500µm; 2"1/2 through 4": 800µm

### OVERALL DIMENSIONS

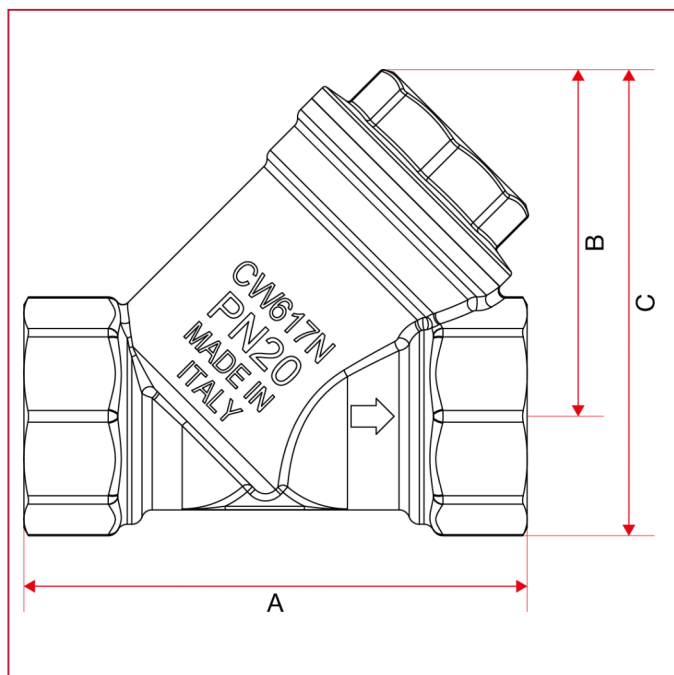



# STRAINERS

	1/4"	3/8"	1/2"	3/4"	1"	1"1/4	1"1/2	2"	2"1/2	3"	4"
DN	8	10	15	20	25	32	40	50	65	80	100
A	55	55	58	70	87	96	106	126	150	169	219
B	40	40	40	48	56	64	73	88,5	105	120	162
C	49,7	51,2	53,25	64,6	76,35	87,7	100	122	147,5	168,5	224,5
Kg/cm2 bar	20	20	20	20	20	20	20	20	16	16	16
LBS - psi	290	290	290	290	290	290	290	290	232	232	232

## MATERIALS sizes 1/4" through 2"

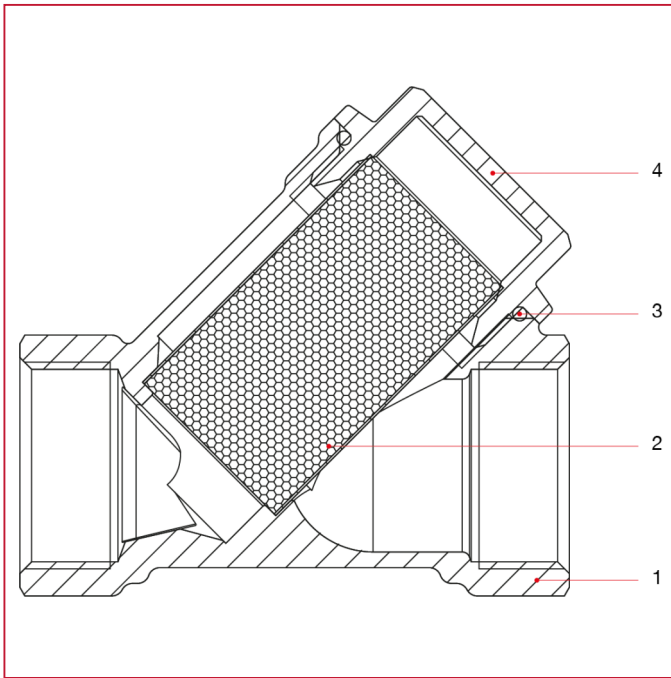

POS.	DESCRIPTION	N.	MATERIAL
1	Body	1	Brass CW617N
2	Strainer	1	Stainless steel AISI 304
3	O-ring	1	NBR
4	End adapter	1	Brass CW617N



# STRAINERS

**MATERIALS sizes 2"1/2 through 4"**

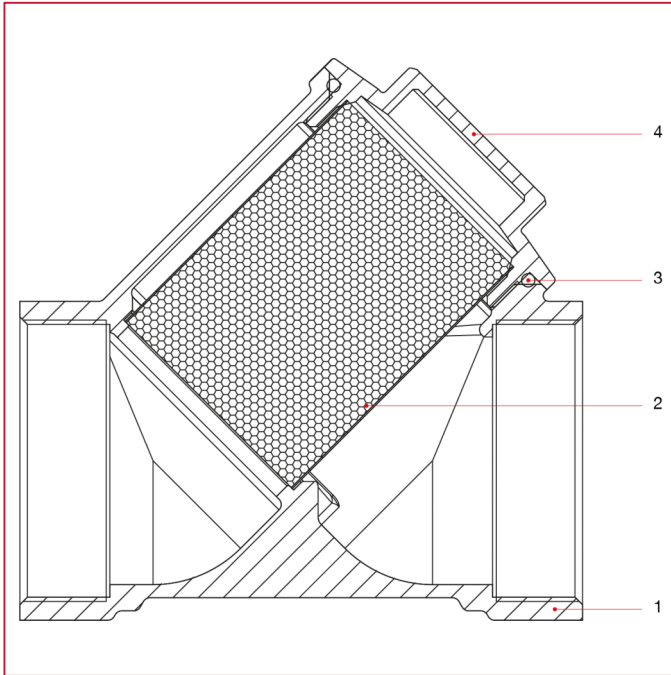

POS.	DESCRIPTION	N.	MATERIAL
1	Body	1	Brass CB753S
2	Strainer	1	Stainless steel AISI 304
3	O-ring	1	NBR
4	End adapter	1	Brass CW617N



# STRAINERS

## INSTRUCTIONS FOR INSTALLATION, MAINTENANCE AND USE - Y Strainer

### INSTALLATION

The Y strainer with metal mesh was designed to prevent solid impurities from entering pipes where they can build up and thus reduce the flow, resulting in greater head losses and oxidation-related problems.

The strainer must be installed upstream of all the system components that can get damaged or lose efficiency due to the presence of impurities.

It is advisable to install shut-off valves both upstream and downstream of the strainer, to facilitate the latter's maintenance.

The filter is normally installed on the inlet to the water supply line before the check valves and the pressure reducers.

For improved filtering efficiency and trapping of solid impurities, the filter body should be installed on horizontal pipes with the cap facing downwards.

For the installation normal hydraulic practices must be used, and especially:

- ones have to be sure that the two pipes are correctly aligned;
- if the fluid contains impurities (dirt, dust, excessive water hardness), these must be removed or filtered out. The hydraulic circuit must be clean;
- when making the plumbing connections, be careful to avoid excessive mechanical stress on the threading and/or fittings in general: over time these may break and cause leakages, which may damage objects and/or harm people;
- it is forbidden to use the device for any purpose other than its intended use;
- if the device is coupled with other components of the system, this must be done by taking into account the operating characteristics of both: incorrect coupling could jeopardise the operation of the device and/or system;
- make sure that the fluid flows in the direction of the arrow printed on the valve body.

### DISASSEMBLY

To deinstall the devices from the line or, nonetheless, before unscrewing the couplings connected to them:

- wear the protective clothing normally required for working with the fluid contained in the line;
- depressurize the line and operate in this way:
- during dismantling, apply the spanner to the end of the filter nearest to the pipe;

### MAINTENANCE

Impurity collectors require regular maintenance for cleaning the stainless steel filtering element and eliminating any impurities deposited inside the cap.

To perform these operations:

- carefully unscrew the blind cap;
- extract the stainless steel filter and clean it with water or compressed air;
- mount it back on by slotting it into the relevant cap housing for optimal positioning, taking care to ensure that the seal and/or O-ring between the body and the cap are properly positioned.

### WARNINGS

- 1 flow manifold in nickel-plated brass with flow meter
- all installations should be performed in accordance with existing local installation regulations and codes of practice where they exist;
- it is mandatory to follow the instructions supplied by the filter manufacturer and by the plant manufacturer, including those specifying how to properly position the filter connection.



## STRAINERS

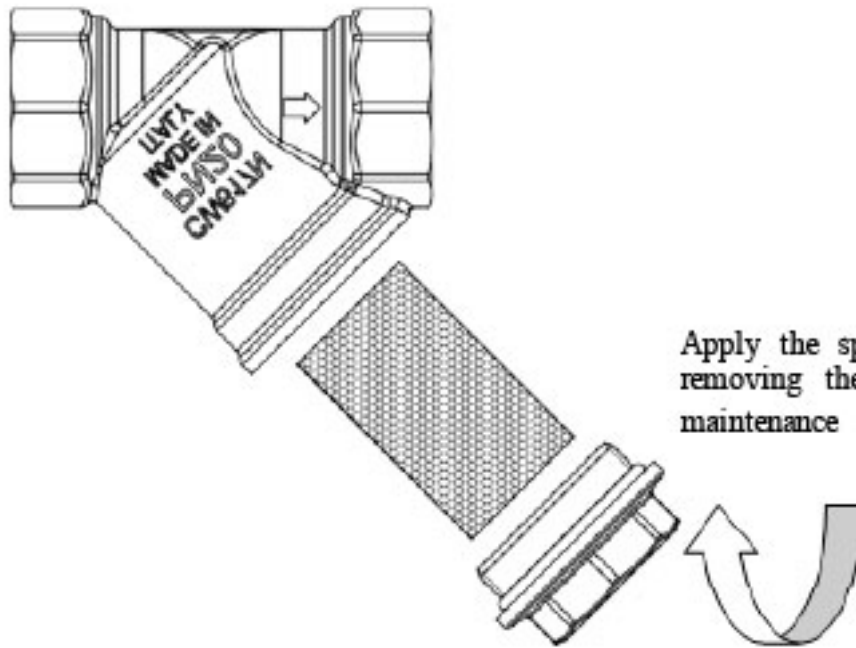

Apply the spanner here when removing the cap to perform maintenance



# STRAINERS

## LOSS DIAGRAM (With water)

	1/4"	3/8"	1/2"	3/4"	1"	1"1/4"	1"1/2"	2"	2"1/2"	3"	4"
KV	2,20	3,40	3,80	7,20	11	13	15	28	77	93	146

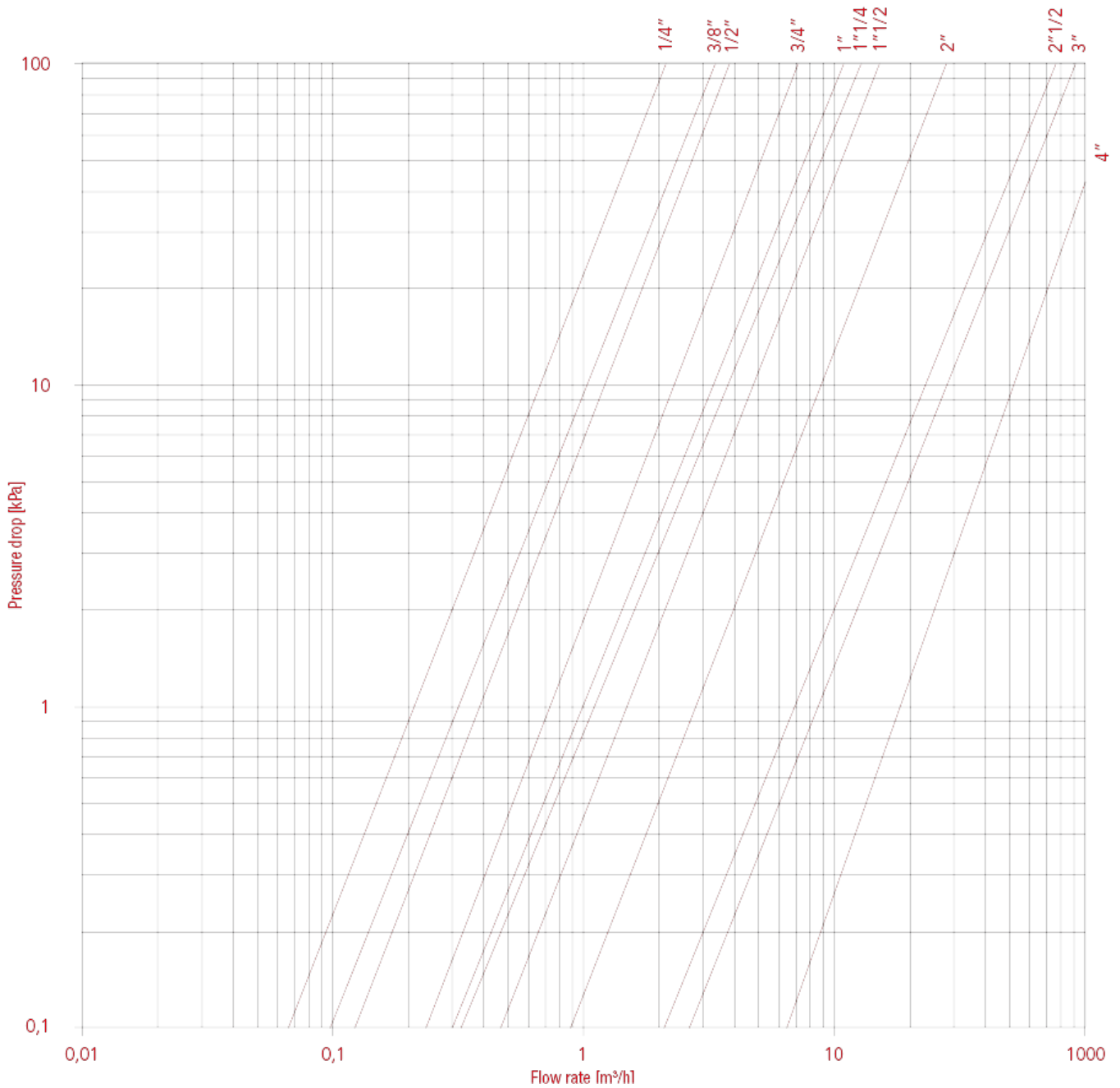





# STRAINERS

## PRESSURE-TEMPERATURE DIAGRAM

The values shown by the dropping lines state the maximum limit of employment of the valves.  
The shown values are approximate.

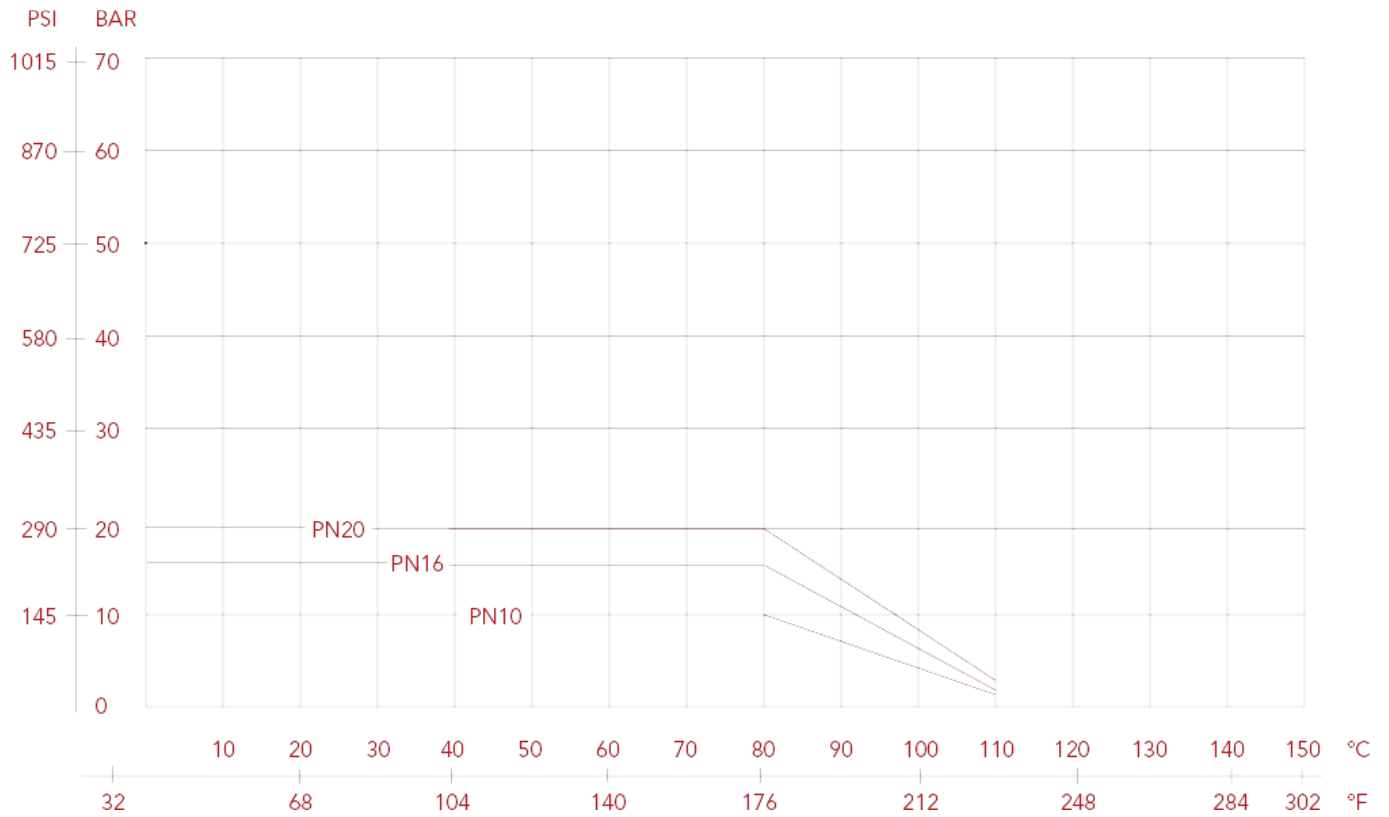



# STRAINERS

## 192CA Cartridge for Y strainer 192

### Y STRAINER



SIZE	CODE	PACKING	STRAINER
1/4" (DN 8)	192CA014	1/0	1/4"
1/4" (DN 8)	192CA014	1/0	3/8"
1/4" (DN 8)	192CA014	1/0	1/2"
3/4" (DN 20)	192CA034	1/0	3/4"
1" (DN 25)	192CA100	1/0	1"
1"1/4 (DN 32)	192CA114	1/0	1"1/4
1"1/2 (DN 40)	192CA112	1/0	1"1/2
2" (DN 50)	192CA200	1/0	2"
2"1/2 (DN 65)	192CA212	1/0	2"1/2
3" (DN 80)	192CA300	1/0	3"
4" (DN 100)	192CA400	1/0	4"

### TECHNICAL SPECIFICATIONS

Filtration degree:

- 1/4" through 2" 500µm;
- 2"1/2, 3", 4" 800µm.

### OVERALL DIMENSIONS

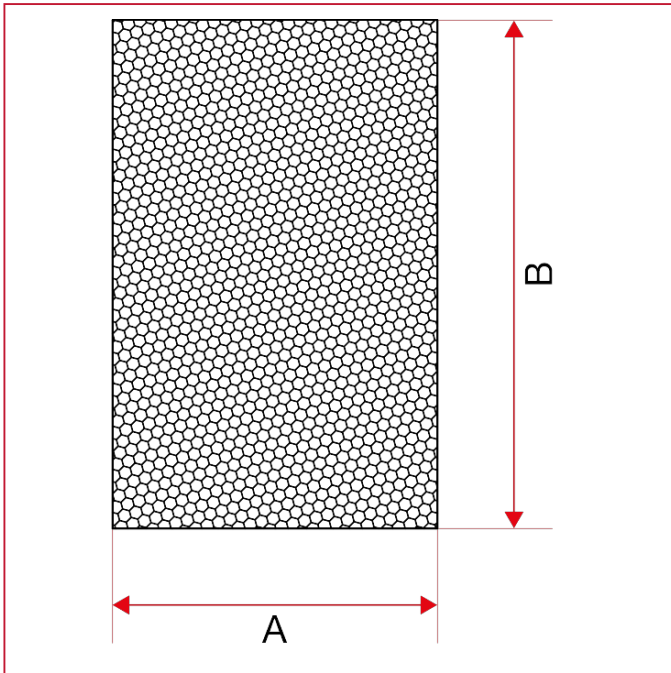

	1/4"	1/4"	1/4"	3/4"	1"	1"1/4	1"1/2	2"	2"1/2	3"	4"
DN	8	8	8	20	25	32	40	50	65	80	100
A	18	18	18	24	30	36	42	53	63	74	102
B	32	32	32	41	47	50	57	70	83,5	89,5	129,5



# STRAINERS

## MATERIALS

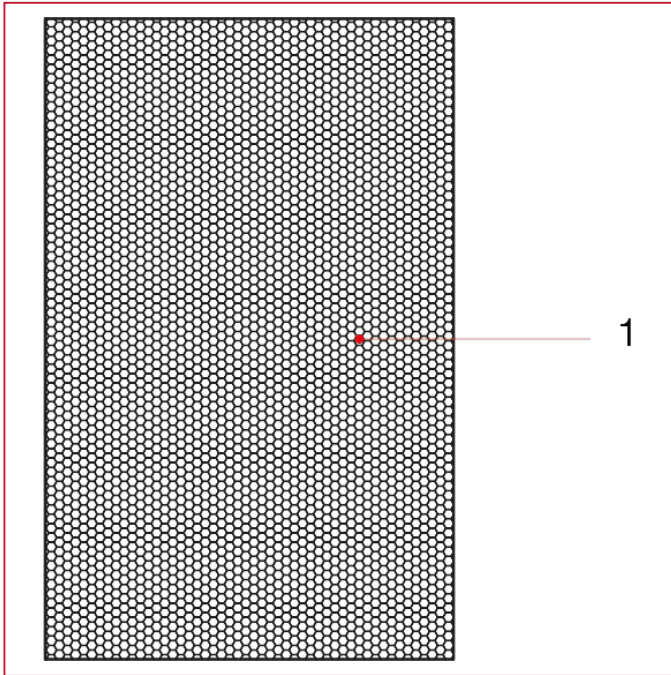

POS.	DESCRIPTION	N.	MATERIAL
1	Cartridge	1	Stainless steel AISI 304



# STRAINERS

## 192 Y strainer

Suitable for domestic water services, heating and air-conditioning plants, compressed air systems.

Y STRAINER



SIZE	PRESSURE	CODE	PACKING
1/4" (DN 8)	20bar/290psi	1920014A	20/140
3/8" (DN 10)	20bar/290psi	1920038A	20/140
1/2" (DN 15)	20bar/290psi	1920012A	20/140
3/4" (DN 20)	20bar/290psi	1920034A	10/70
1" (DN 25)	20bar/290psi	1920100A	8/48
1"1/4 (DN 32)	20bar/290psi	1920114A	5/30
1"1/2 (DN 40)	20bar/290psi	1920112A	2/18
2" (DN 50)	20bar/290psi	1920200A	2/10

### CERTIFICATIONS



### TECHNICAL SPECIFICATIONS

Female/female threads and inspection plug.

Body in brass.

Minimum and maximum working temperatures: -20°C, 110°C in absence of steam.

Threads: ISO 228 (equivalent to DIN EN ISO 228 and BS EN ISO 228).

Filtration degree: 1/4" through 2" 200µm

### OVERALL DIMENSIONS

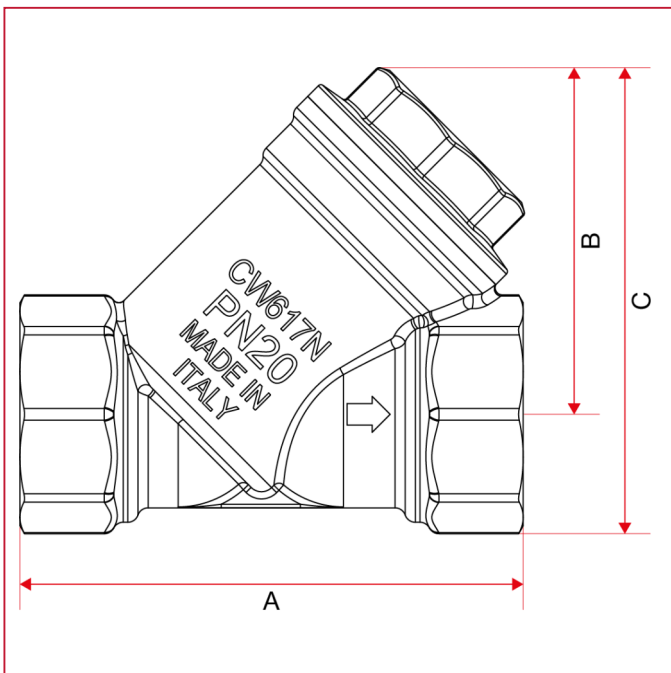



# STRAINERS

	1/4"	3/8"	1/2"	3/4"	1"	1"1/4	1"1/2	2"
DN	8	10	15	20	25	32	40	50
A	55	55	58	70	87	96	106	126
B	40	40	40	48	56	64	73	88,5
C	49,7	51,2	53,25	64,6	76,35	87,7	100	122
Kg/cm2 bar	20	20	20	20	20	20	20	20
LBS - psi	290	290	290	290	290	290	290	290

## MATERIALS

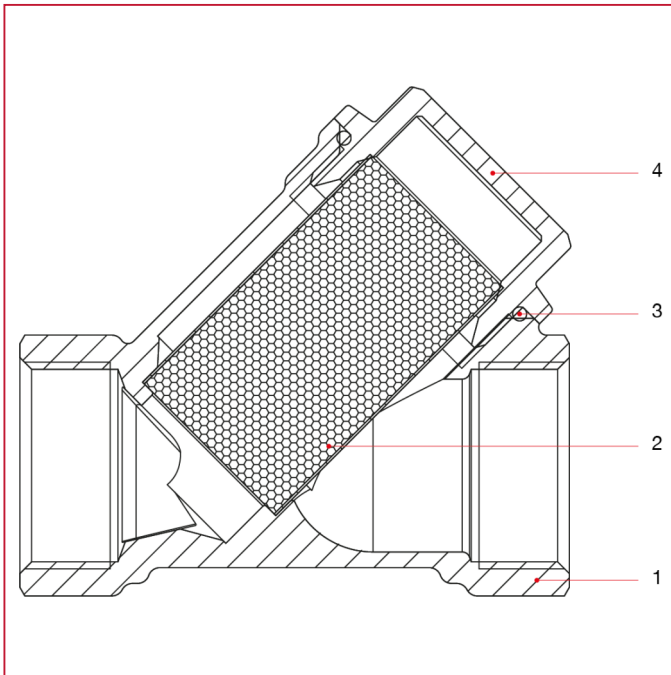

POS.	DESCRIPTION	N.	MATERIAL
1	Body	1	Brass CW617N
2	Strainer	1	Stainless steel AISI 304
3	O-ring	1	NBR
4	End adapter	1	Brass CW617N



# STRAINERS

## INSTRUCTIONS FOR INSTALLATION, MAINTENANCE AND USE - Y Strainer

### INSTALLATION

The Y strainer with metal mesh was designed to prevent solid impurities from entering pipes where they can build up and thus reduce the flow, resulting in greater head losses and oxidation-related problems.

The strainer must be installed upstream of all the system components that can get damaged or lose efficiency due to the presence of impurities.

It is advisable to install shut-off valves both upstream and downstream of the strainer, to facilitate the latter's maintenance.

The filter is normally installed on the inlet to the water supply line before the check valves and the pressure reducers.

For improved filtering efficiency and trapping of solid impurities, the filter body should be installed on horizontal pipes with the cap facing downwards.

For the installation normal hydraulic practices must be used, and especially:

- ones have to be sure that the two pipes are correctly aligned;
- if the fluid contains impurities (dirt, dust, excessive water hardness), these must be removed or filtered out. The hydraulic circuit must be clean;
- when making the plumbing connections, be careful to avoid excessive mechanical stress on the threading and/or fittings in general: over time these may break and cause leakages, which may damage objects and/or harm people;
- it is forbidden to use the device for any purpose other than its intended use;
- if the device is coupled with other components of the system, this must be done by taking into account the operating characteristics of both: incorrect coupling could jeopardise the operation of the device and/or system;
- make sure that the fluid flows in the direction of the arrow printed on the valve body.

### DISASSEMBLY

To deinstall the devices from the line or, nonetheless, before unscrewing the couplings connected to them:

- wear the protective clothing normally required for working with the fluid contained in the line;
- depressurize the line and operate in this way:
- during dismantling, apply the spanner to the end of the filter nearest to the pipe;

### MAINTENANCE

Impurity collectors require regular maintenance for cleaning the stainless steel filtering element and eliminating any impurities deposited inside the cap.

To perform these operations:

- carefully unscrew the blind cap;
- extract the stainless steel filter and clean it with water or compressed air;
- mount it back on by slotting it into the relevant cap housing for optimal positioning, taking care to ensure that the seal and/or O-ring between the body and the cap are properly positioned.

### WARNINGS

- 1 flow manifold in nickel-plated brass with flow meter
- all installations should be performed in accordance with existing local installation regulations and codes of practice where they exist;
- it is mandatory to follow the instructions supplied by the filter manufacturer and by the plant manufacturer, including those specifying how to properly position the filter connection.



## STRAINERS

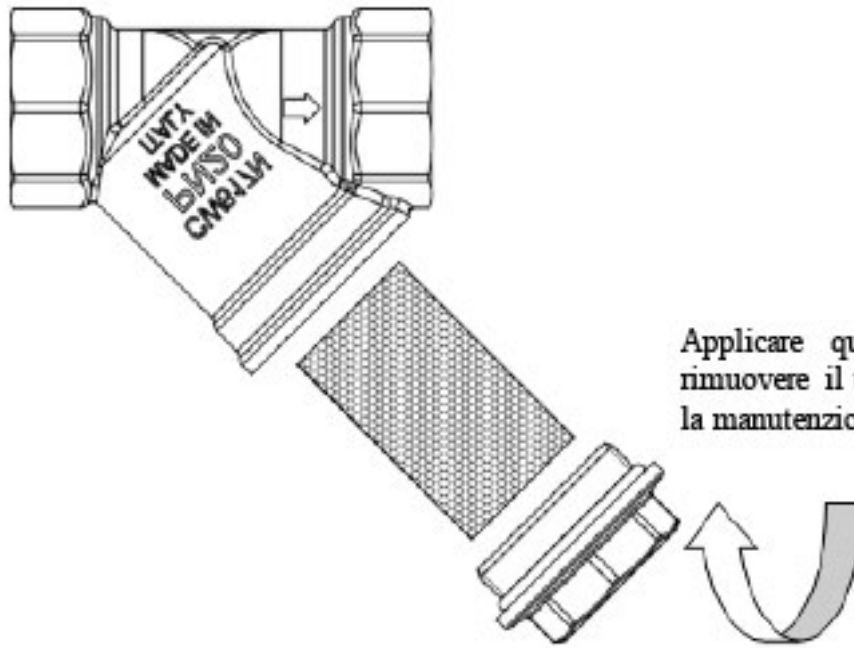



# STRAINERS

## LOSS DIAGRAM (With water)

	1/4"	3/8"	1/2"	3/4"	1"	1"1/4"	1"1/2"	2"
KV	1,7	2,4	3,5	6,5	8	10	11,5	19,6

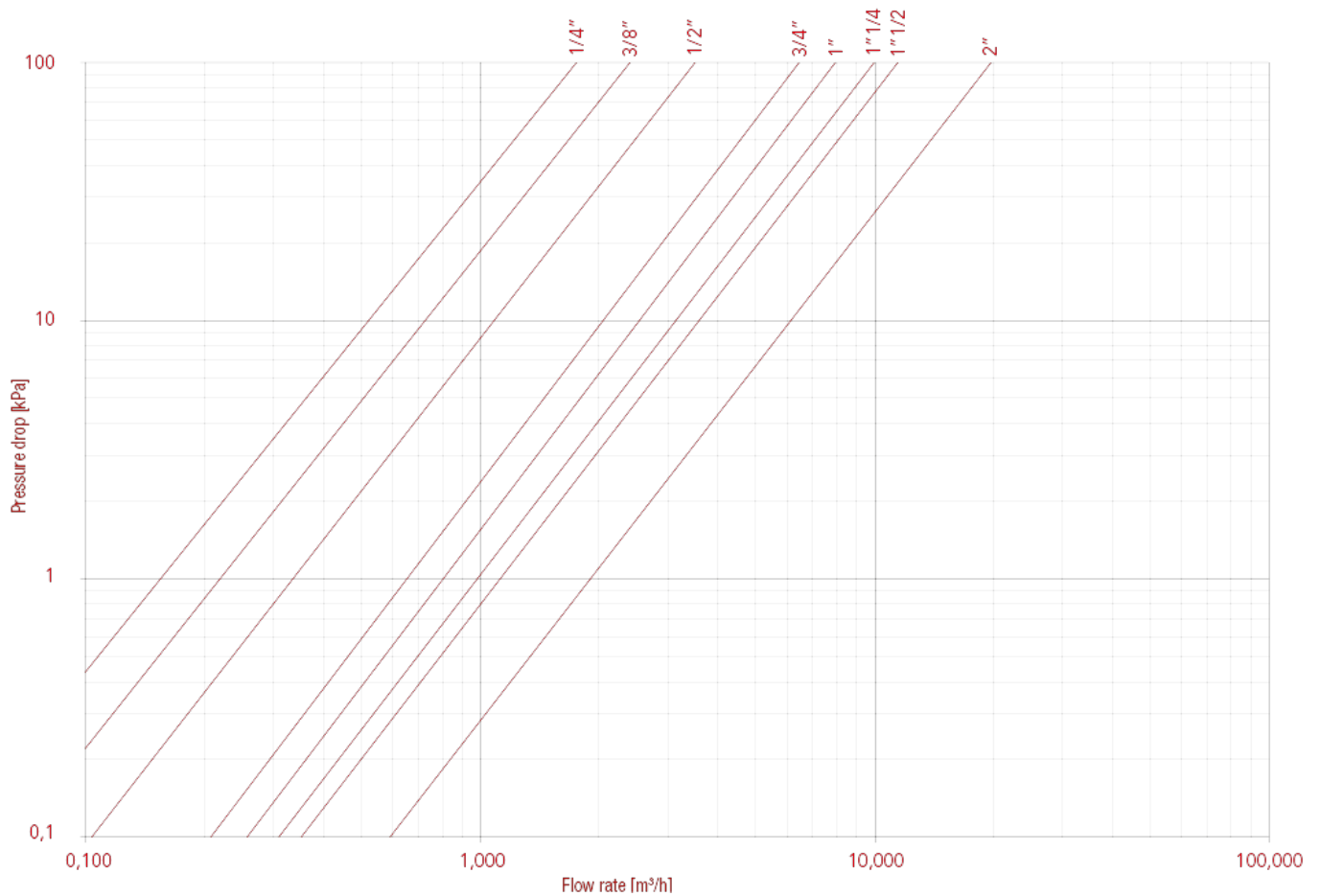





# STRAINERS

## PRESSURE-TEMPERATURE DIAGRAM

The values shown by the dropping lines state the maximum limit of employment of the valves.  
The shown values are approximate.

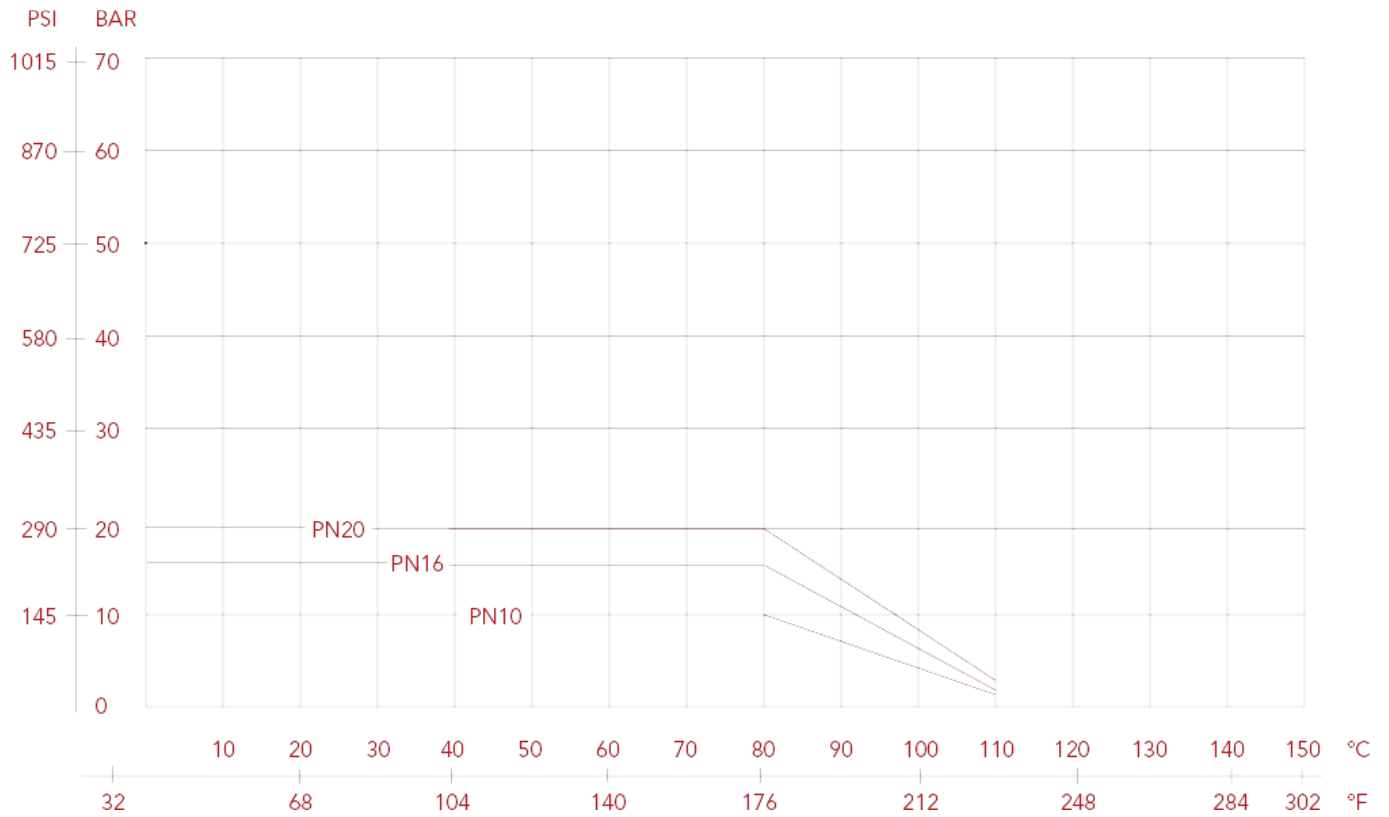



# STRAINERS

## 192CA Cartridge for Y strainer 192

### Y STRAINER



SIZE	CODE	PACKING	STRAINER
1/4" (DN 8)	192CA014A	1/0	1/4"
1/4" (DN 8)	192CA014A	1/0	3/8"
1/4" (DN 8)	192CA014A	1/0	1/2"
3/4" (DN 20)	192CA034A	1/0	3/4"
1" (DN 25)	192CA100A	1/0	1"
1"1/4 (DN 32)	192CA114A	1/0	1"1/4
1"1/2 (DN 40)	192CA112A	1/0	1"1/2
2" (DN 50)	192CA200A	1/0	2"

### TECHNICAL SPECIFICATIONS

Filtration degree: 1/4" through 2" 200µm

### OVERALL DIMENSIONS

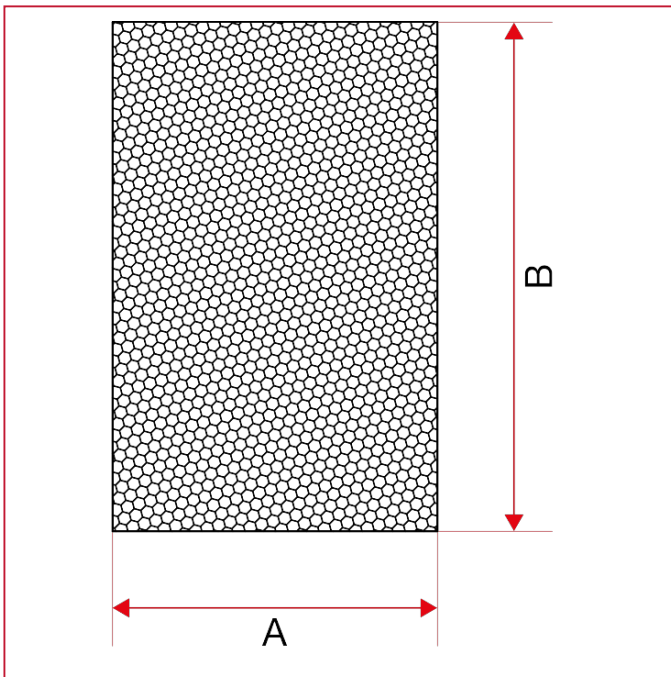

	1/4"	1/4"	1/4"	3/4"	1"	1"1/4	1"1/2	2"
DN	8	8	8	20	25	32	40	50
A	18	18	18	24	30	36	42	53
B	32	32	32	41	47	50	57	70



# STRAINERS

## MATERIALS

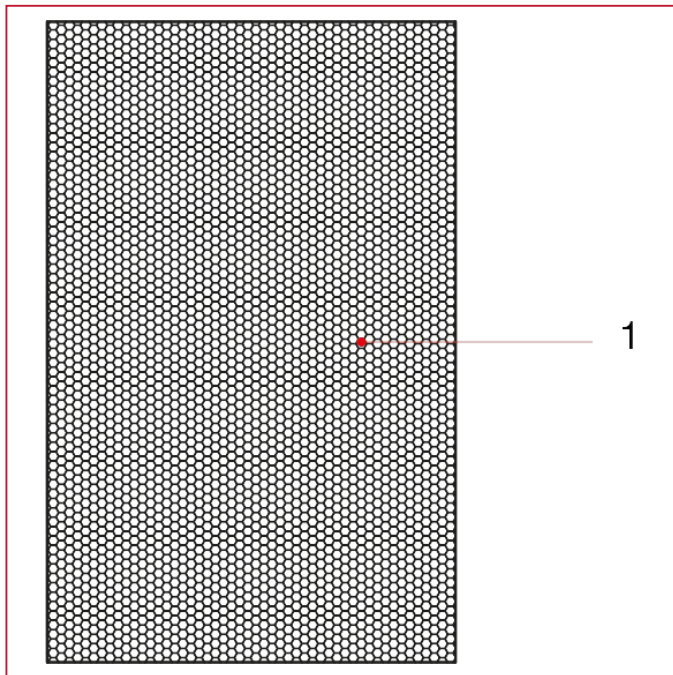

POS.	DESCRIPTION	N.	MATERIAL
1	Cartridge	1	Stainless steel AISI 304



# STRAINERS

## 193 Nickel-plated Y strainer

Suitable for domestic water services, heating and air-conditioning plants, compressed air systems.

Y STRAINER



SIZE	PRESSURE	CODE	PACKING
1/4" (DN 8)	20bar/290psi	1930014	20/140
3/8" (DN 10)	20bar/290psi	1930038	20/140
1/2" (DN 15)	20bar/290psi	1930012	20/140
3/4" (DN 20)	20bar/290psi	1930034	10/70
1" (DN 25)	20bar/290psi	1930100	8/48
1"1/4" (DN 32)	20bar/290psi	1930114	5/30
1"1/2" (DN 40)	20bar/290psi	1930112	2/18
2" (DN 50)	20bar/290psi	1930200	2/10

### CERTIFICATIONS



### TECHNICAL SPECIFICATIONS

Female/female threads and inspection plug.

Body in nickel-plated brass.

Minimum and maximum working temperatures: -20°C, 110°C in absence of steam.

Threads: ISO 228 (equivalent to DIN EN ISO 228 and BS EN ISO 228).

Filtration degree: 500µm

### OVERALL DIMENSIONS

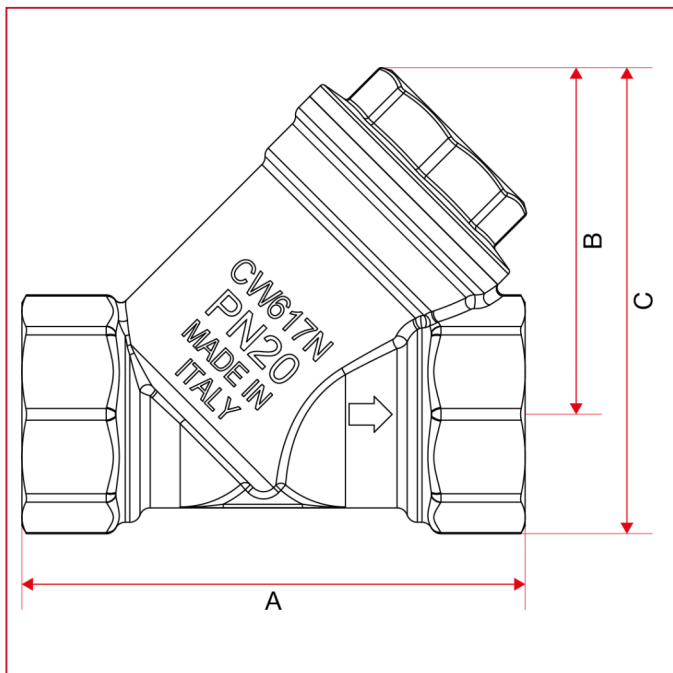



# STRAINERS

	1/4"	3/8"	1/2"	3/4"	1"	1"1/4	1"1/2	2"
DN	8	10	15	20	25	32	40	50
A	55	55	58	70	87	96	106	126
B	40	40	40	48	56	64	73	88,5
C	49,7	51,2	53,25	64,6	76,35	87,7	100	122
Kg/cm2 bar	20	20	20	20	20	20	20	20
LBS - psi	290	290	290	290	290	290	290	290

## MATERIALS

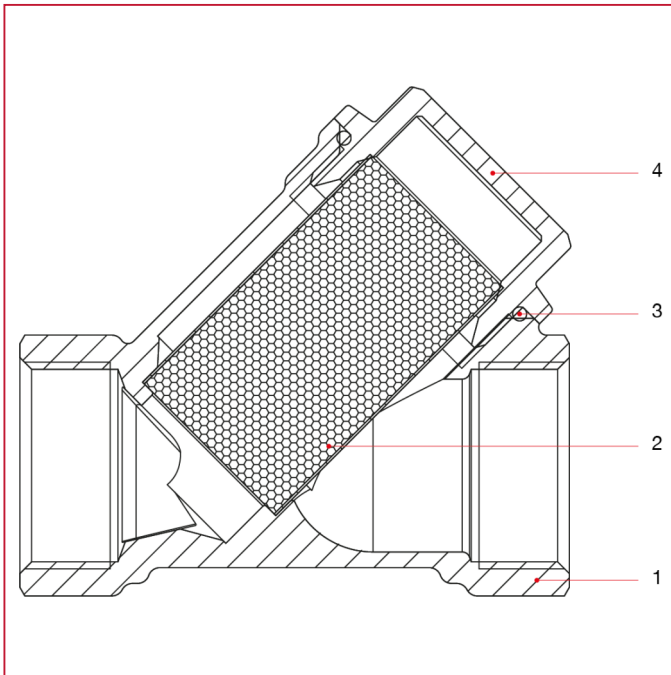

POS.	DESCRIPTION	N.	MATERIAL
1	Body	1	Nickel-plated brass CW617N
2	Strainer	1	Stainless steel AISI 304
3	O-ring	1	NBR
4	End adapter	1	Nickel-plated brass CW617N



# STRAINERS

## INSTRUCTIONS FOR INSTALLATION, MAINTENANCE AND USE - Y Strainer

### INSTALLATION

The Y strainer with metal mesh was designed to prevent solid impurities from entering pipes where they can build up and thus reduce the flow, resulting in greater head losses and oxidation-related problems.

The strainer must be installed upstream of all the system components that can get damaged or lose efficiency due to the presence of impurities.

It is advisable to install shut-off valves both upstream and downstream of the strainer, to facilitate the latter's maintenance.

The filter is normally installed on the inlet to the water supply line before the check valves and the pressure reducers.

For improved filtering efficiency and trapping of solid impurities, the filter body should be installed on horizontal pipes with the cap facing downwards.

For the installation normal hydraulic practices must be used, and especially:

- ones have to be sure that the two pipes are correctly aligned;
- if the fluid contains impurities (dirt, dust, excessive water hardness), these must be removed or filtered out. The hydraulic circuit must be clean;
- when making the plumbing connections, be careful to avoid excessive mechanical stress on the threading and/or fittings in general: over time these may break and cause leakages, which may damage objects and/or harm people;
- it is forbidden to use the device for any purpose other than its intended use;
- if the device is coupled with other components of the system, this must be done by taking into account the operating characteristics of both: incorrect coupling could jeopardise the operation of the device and/or system;
- make sure that the fluid flows in the direction of the arrow printed on the valve body.

### DISASSEMBLY

To deinstall the devices from the line or, nonetheless, before unscrewing the couplings connected to them:

- wear the protective clothing normally required for working with the fluid contained in the line;
- depressurize the line and operate in this way:
- during dismantling, apply the spanner to the end of the filter nearest to the pipe;

### MAINTENANCE

Impurity collectors require regular maintenance for cleaning the stainless steel filtering element and eliminating any impurities deposited inside the cap.

To perform these operations:

- carefully unscrew the blind cap;
- extract the stainless steel filter and clean it with water or compressed air;
- mount it back on by slotting it into the relevant cap housing for optimal positioning, taking care to ensure that the seal and/or O-ring between the body and the cap are properly positioned.

### WARNINGS

- 1 flow manifold in nickel-plated brass with flow meter
- all installations should be performed in accordance with existing local installation regulations and codes of practice where they exist;
- it is mandatory to follow the instructions supplied by the filter manufacturer and by the plant manufacturer, including those specifying how to properly position the filter connection.



## STRAINERS

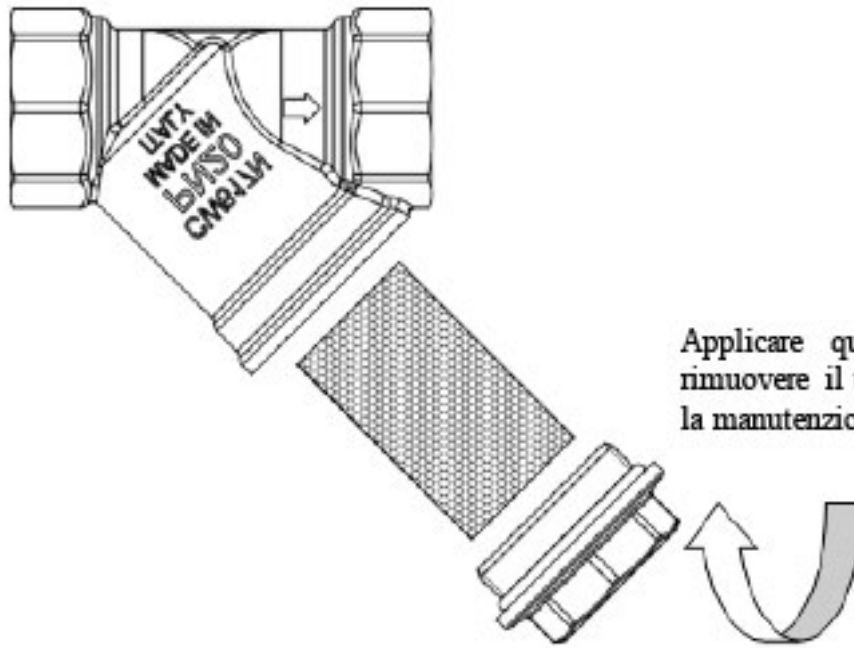

Applicare qui la chiave nel  
rimuovere il tappo per eseguire  
la manutenzione



# STRAINERS

## LOSS DIAGRAM (With water)

	1/4"	3/8"	1/2"	3/4"	1"	1"1/4"	1"1/2"	2"
KV	2,20	3,40	3,80	7,20	11	13	15	28

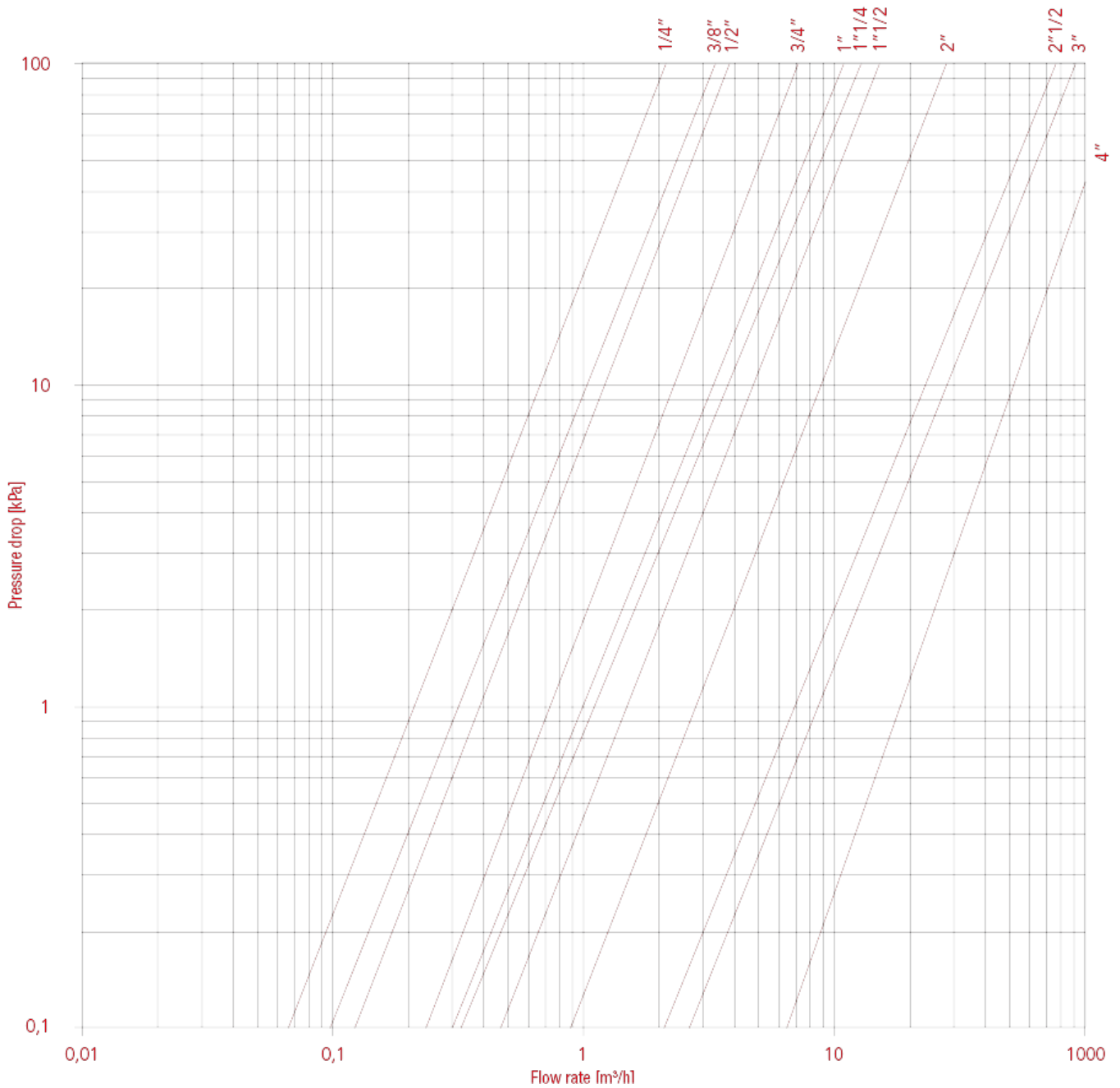





# STRAINERS

## PRESSURE-TEMPERATURE DIAGRAM

The values shown by the dropping lines state the maximum limit of employment of the valves.  
The shown values are approximate.

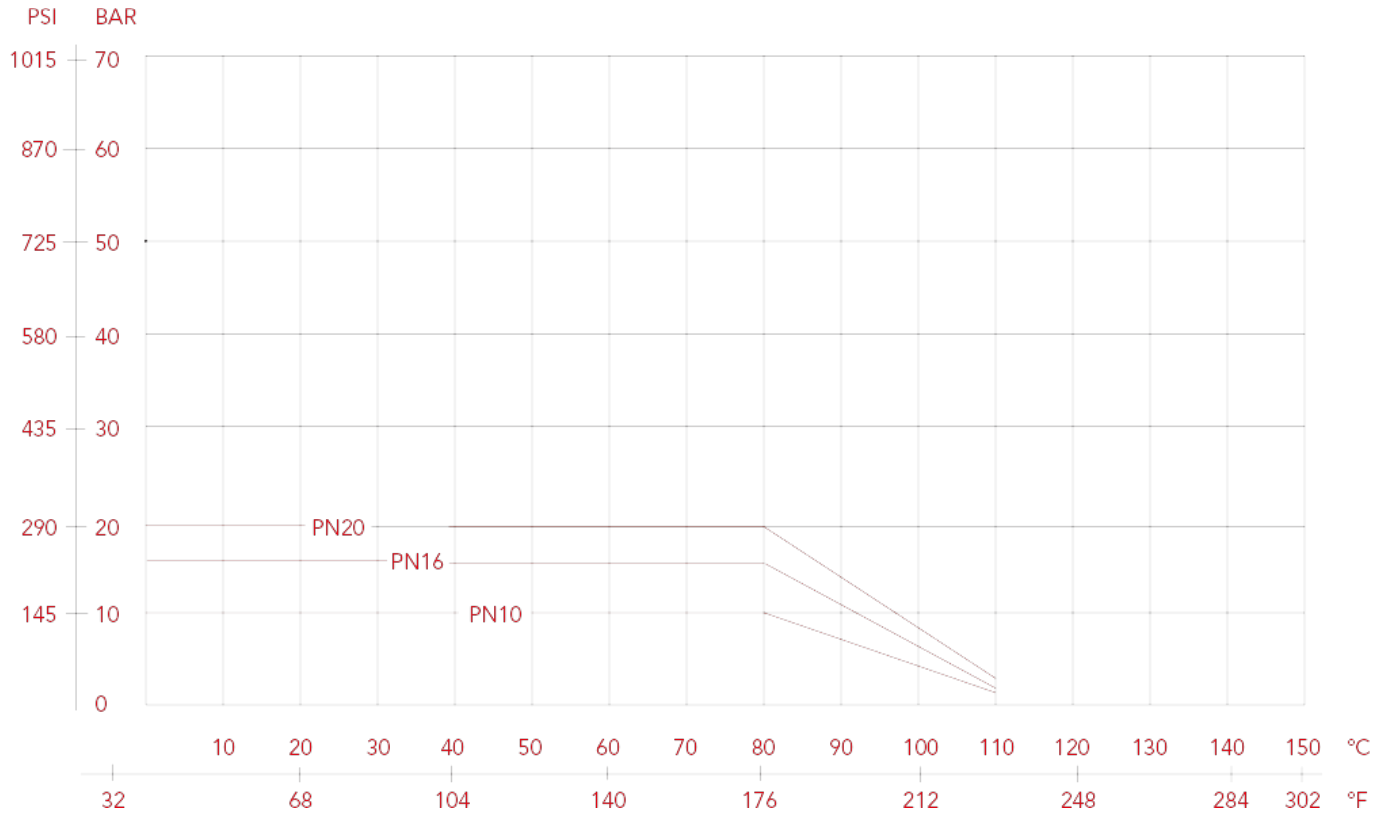



# STRAINERS

## 192CA Cartridge for Y strainer 193

### Y STRAINER



SIZE	CODE	PACKING	STRAINER
1/4" (DN 8)	192CA014	1/0	1/4"
1/4" (DN 8)	192CA014	1/0	3/8"
1/4" (DN 8)	192CA014	1/0	1/2"
3/4" (DN 20)	192CA034	1/0	3/4"
1" (DN 25)	192CA100	1/0	1"
1"1/4 (DN 32)	192CA114	1/0	1"1/4
1"1/2 (DN 40)	192CA112	1/0	1"1/2
2" (DN 50)	192CA200	1/0	2"

### TECHNICAL SPECIFICATIONS

Filtration degree: 500µm

### OVERALL DIMENSIONS

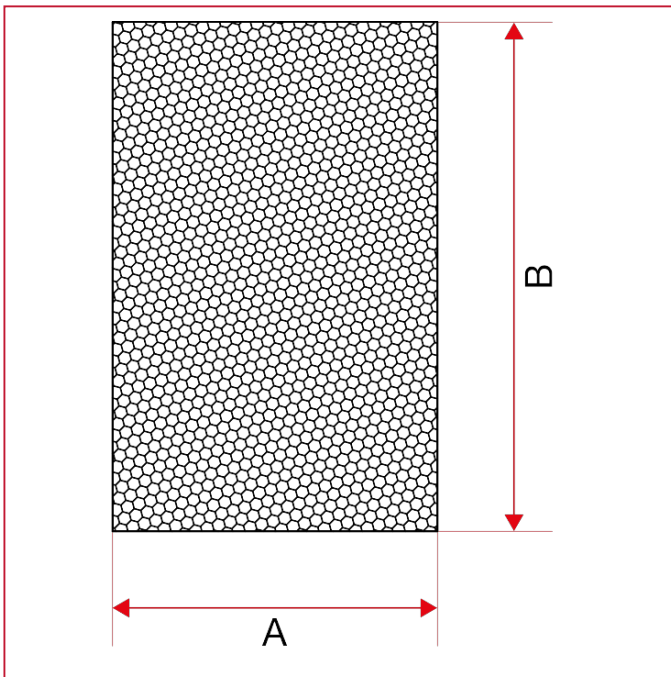

	1/4"	1/4"	1/4"	3/4"	1"	1"1/4	1"1/2	2"
DN	8	8	8	20	25	32	40	50
A	18	18	18	24	30	36	42	53
B	32	32	32	41	47	50	57	70



# STRAINERS

## MATERIALS

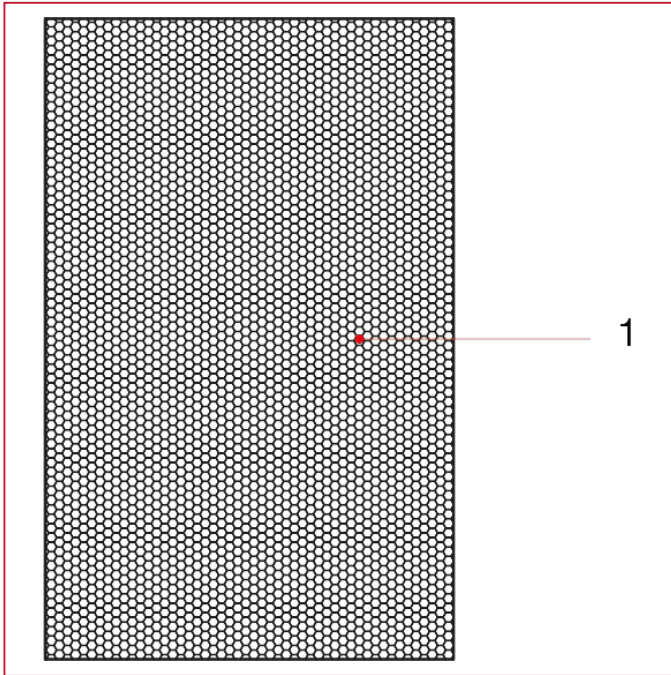

POS.	DESCRIPTION	N.	MATERIAL
1	Cartridge	1	Stainless steel AISI 304



# STRAINERS

## 193 Nickel-plated Y strainer

Suitable for domestic water services, heating and air-conditioning plants, compressed air systems.

Y STRAINER



SIZE	PRESSURE	CODE	PACKING
1/4" (DN 8)	20bar/290psi	1930014G	20/140
3/8" (DN 10)	20bar/290psi	1930038G	20/140
1/2" (DN 15)	20bar/290psi	1930012G	20/140
3/4" (DN 20)	20bar/290psi	1930034G	10/70
1" (DN 25)	20bar/290psi	1930100G	8/48
1"1/4 (DN 32)	20bar/290psi	1930114G	5/30
1"1/2 (DN 40)	20bar/290psi	1930112G	2/18
2" (DN 50)	20bar/290psi	1930200G	2/10

### CERTIFICATIONS



### TECHNICAL SPECIFICATIONS

Female/female threads and inspection plug.

Body in nickel-plated brass.

Minimum and maximum working temperatures: -20°C, 110°C in absence of steam.

Threads: ISO 228 (equivalent to DIN EN ISO 228 and BS EN ISO 228).

Filtration degree: 300µm

### OVERALL DIMENSIONS

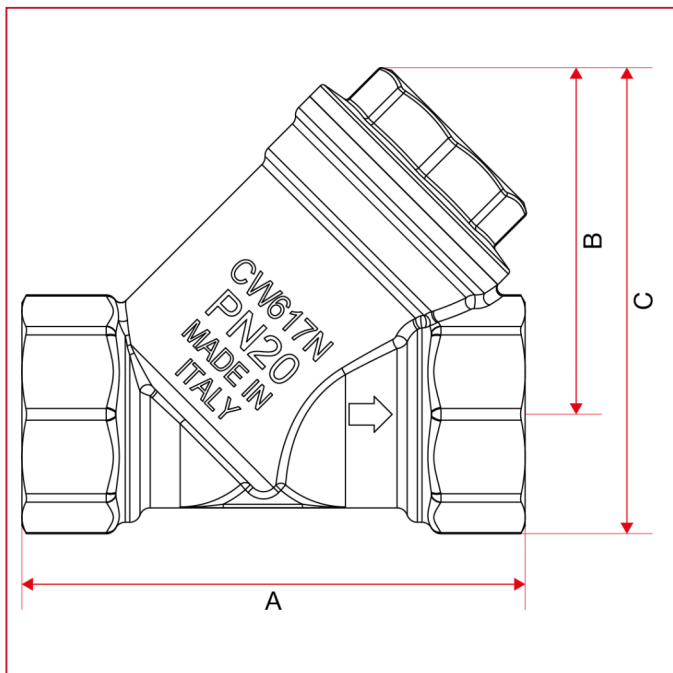



# STRAINERS

	1/4"	3/8"	1/2"	3/4"	1"	1"1/4	1"1/2	2"
DN	8	10	15	20	25	32	40	50
A	55	55	58	70	87	96	106	126
B	40	40	40	48	56	64	73	88,5
C	49,7	51,2	53,25	64,6	76,35	87,7	100	122
Kg/cm2 bar	20	20	20	20	20	20	20	20
LBS - psi	290	290	290	290	290	290	290	290

## MATERIALS

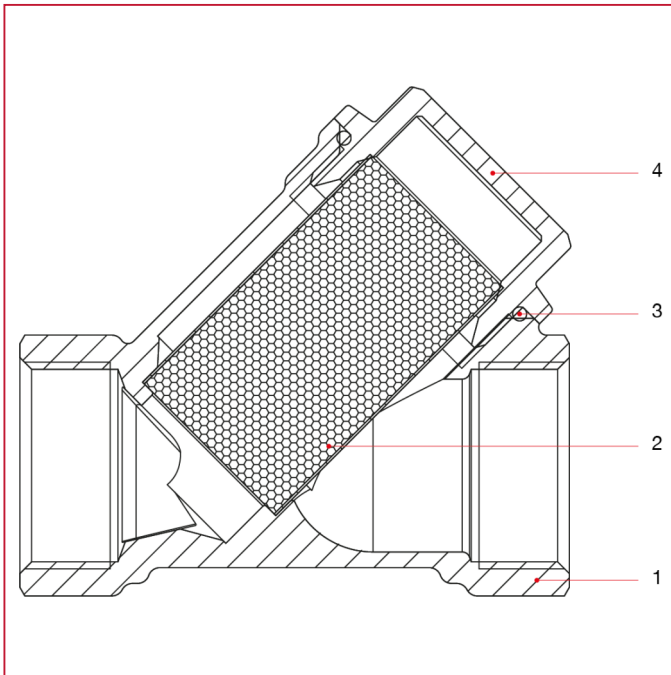

POS.	DESCRIPTION	N.	MATERIAL
1	Body	1	Nickel-plated brass CW617N
2	Strainer	1	Stainless steel AISI 304
3	O-ring	1	NBR
4	End adapter	1	Nickel-plated brass CW617N



# STRAINERS

## INSTRUCTIONS FOR INSTALLATION, MAINTENANCE AND USE - Y Strainer

### INSTALLATION

The Y strainer with metal mesh was designed to prevent solid impurities from entering pipes where they can build up and thus reduce the flow, resulting in greater head losses and oxidation-related problems.

The strainer must be installed upstream of all the system components that can get damaged or lose efficiency due to the presence of impurities.

It is advisable to install shut-off valves both upstream and downstream of the strainer, to facilitate the latter's maintenance.

The filter is normally installed on the inlet to the water supply line before the check valves and the pressure reducers.

For improved filtering efficiency and trapping of solid impurities, the filter body should be installed on horizontal pipes with the cap facing downwards.

For the installation normal hydraulic practices must be used, and especially:

- ones have to be sure that the two pipes are correctly aligned;
- if the fluid contains impurities (dirt, dust, excessive water hardness), these must be removed or filtered out. The hydraulic circuit must be clean;
- when making the plumbing connections, be careful to avoid excessive mechanical stress on the threading and/or fittings in general: over time these may break and cause leakages, which may damage objects and/or harm people;
- it is forbidden to use the device for any purpose other than its intended use;
- if the device is coupled with other components of the system, this must be done by taking into account the operating characteristics of both: incorrect coupling could jeopardise the operation of the device and/or system;
- make sure that the fluid flows in the direction of the arrow printed on the valve body.

### DISASSEMBLY

To deinstall the devices from the line or, nonetheless, before unscrewing the couplings connected to them:

- wear the protective clothing normally required for working with the fluid contained in the line;
- depressurize the line and operate in this way:
- during dismantling, apply the spanner to the end of the filter nearest to the pipe;

### MAINTENANCE

Impurity collectors require regular maintenance for cleaning the stainless steel filtering element and eliminating any impurities deposited inside the cap.

To perform these operations:

- carefully unscrew the blind cap;
- extract the stainless steel filter and clean it with water or compressed air;
- mount it back on by slotting it into the relevant cap housing for optimal positioning, taking care to ensure that the seal and/or O-ring between the body and the cap are properly positioned.

### WARNINGS

- 1 flow manifold in nickel-plated brass with flow meter
- all installations should be performed in accordance with existing local installation regulations and codes of practice where they exist;
- it is mandatory to follow the instructions supplied by the filter manufacturer and by the plant manufacturer, including those specifying how to properly position the filter connection.



## STRAINERS

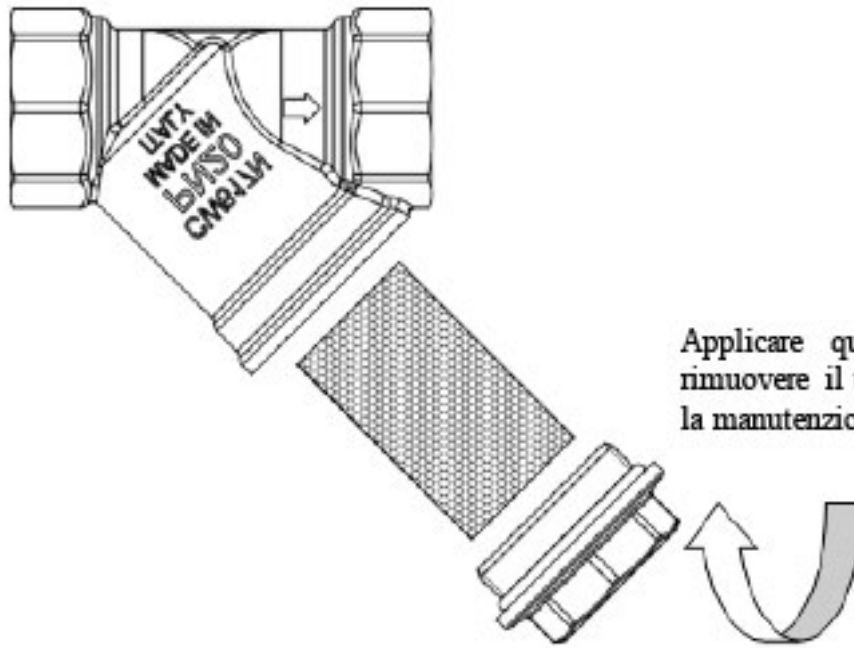



# STRAINERS

## LOSS DIAGRAM (With water)

	1/4"	3/8"	1/2"	3/4"	1"	1"1/4"	1"1/2"	2"
KV	2,20	3,40	3,80	7,20	11	13	15	28

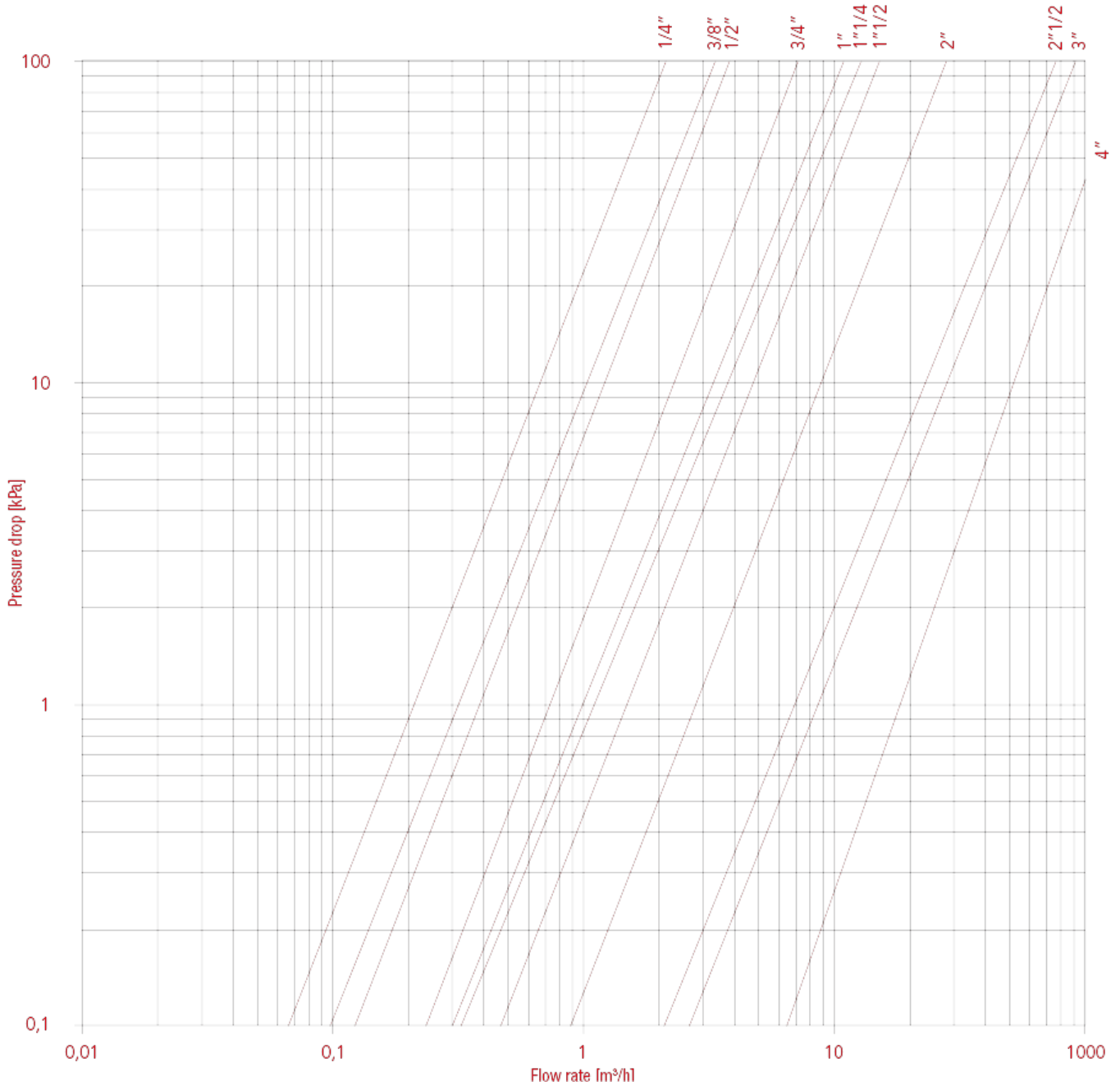





# STRAINERS

## PRESSURE-TEMPERATURE DIAGRAM

The values shown by the dropping lines state the maximum limit of employment of the valves.  
The shown values are approximate.

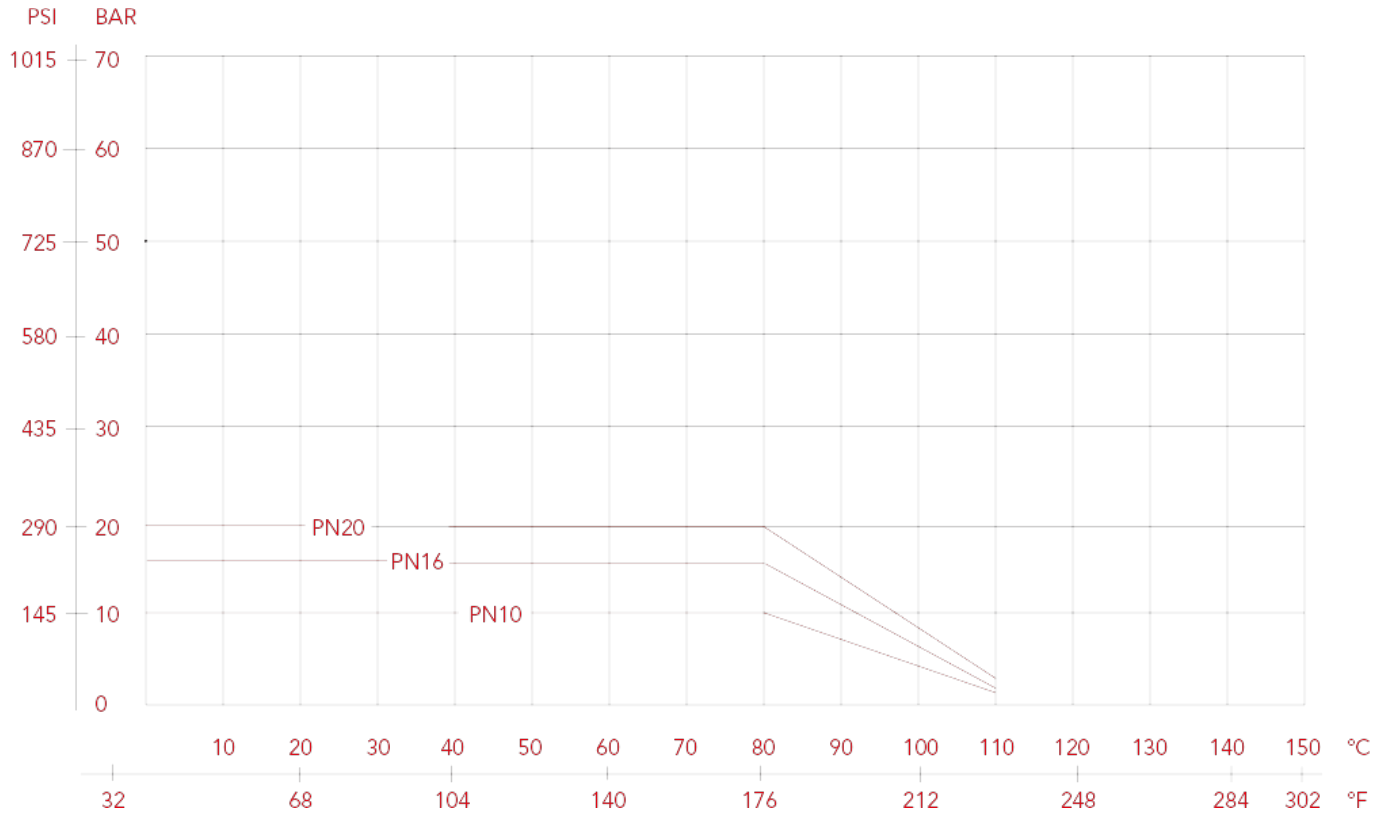



# STRAINERS

## 192CA Cartridge for Y strainer 193

### Y STRAINER



SIZE	CODE	PACKING	STRAINER
1/4" (DN 8)	192CA014G	1/0	1/4"
1/4" (DN 8)	192CA014G	1/0	3/8"
1/4" (DN 8)	192CA014G	1/0	1/2"
3/4" (DN 20)	192CA034G	1/0	3/4"
1" (DN 25)	192CA100G	1/0	1"
1"1/4 (DN 32)	192CA114G	1/0	1"1/4
1"1/2 (DN 40)	192CA112G	1/0	1"1/2
2" (DN 50)	192CA200G	1/0	2"

### TECHNICAL SPECIFICATIONS

Filtration degree: 300µm

### OVERALL DIMENSIONS

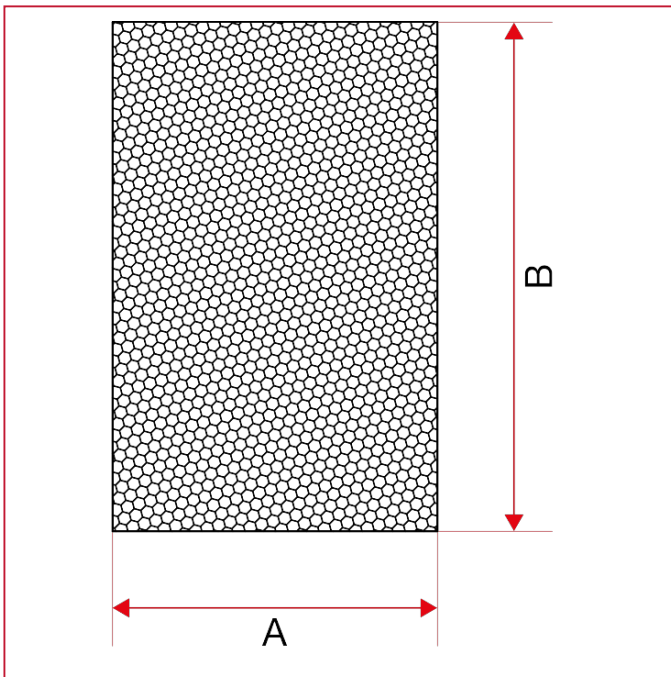

	1/4"	1/4"	1/4"	3/4"	1"	1"1/4	1"1/2	2"
DN	8	8	8	20	25	32	40	50
A	18	18	18	24	30	36	42	53
B	32	32	32	41	47	50	57	70



# STRAINERS

## MATERIALS

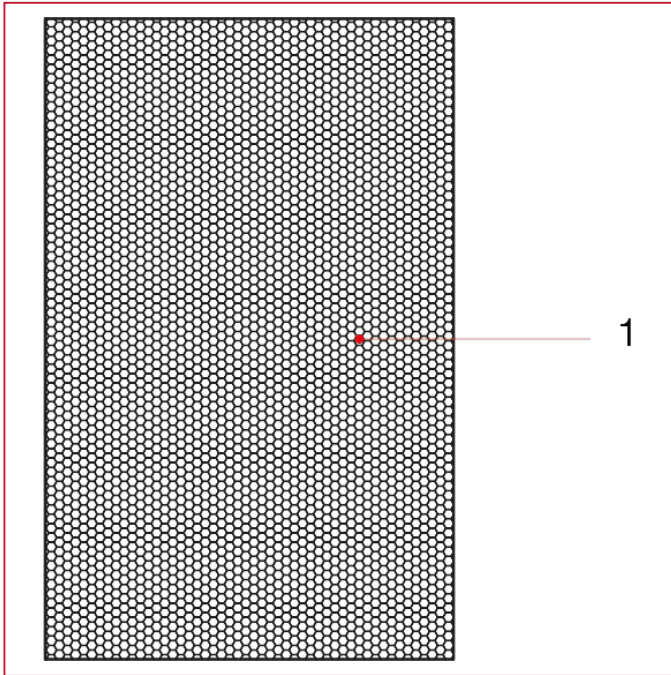

POS.	DESCRIPTION	N.	MATERIAL
1	Cartridge	1	Stainless steel AISI 304



# STRAINERS

## 193 Nickel-plated Y strainer

Suitable for domestic water services, heating and air-conditioning plants, compressed air systems.

Y STRAINER



SIZE	PRESSURE	CODE	PACKING
1/4" (DN 8)	20bar/290psi	1930014GAS	20/140
3/8" (DN 10)	20bar/290psi	1930038GAS	20/140
1/2" (DN 15)	20bar/290psi	1930012GAS	20/140
3/4" (DN 20)	20bar/290psi	1930034GAS	10/70
1" (DN 25)	20bar/290psi	1930100GAS	8/48
1"1/4" (DN 32)	20bar/290psi	1930114GAS	5/30
1"1/2" (DN 40)	20bar/290psi	1930112GAS	2/18
2" (DN 50)	20bar/290psi	1930200GAS	2/10

### CERTIFICATIONS



### TECHNICAL SPECIFICATIONS

Female/female threads and inspection plug.

Body in nickel-plated brass.

Minimum and maximum working temperatures: -20°C, 110°C in absence of steam.

Threads: ISO 228 (equivalent to DIN EN ISO 228 and BS EN ISO 228).

Filtration degree: 50µm

### OVERALL DIMENSIONS

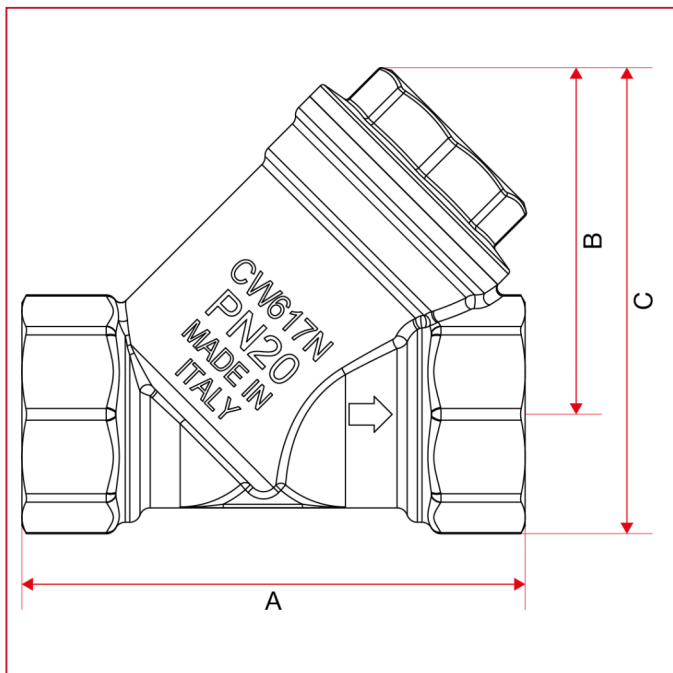



# STRAINERS

	1/4"	3/8"	1/2"	3/4"	1"	1"1/4	1"1/2	2"
DN	8	10	15	20	25	32	40	50
A	55	55	58	70	87	96	106	126
B	40	40	40	48	56	64	73	88,5
C	49,7	51,2	53,25	64,6	76,35	87,7	100	122
Kg/cm2 bar	20	20	20	20	20	20	20	20
LBS - psi	290	290	290	290	290	290	290	290

## MATERIALS

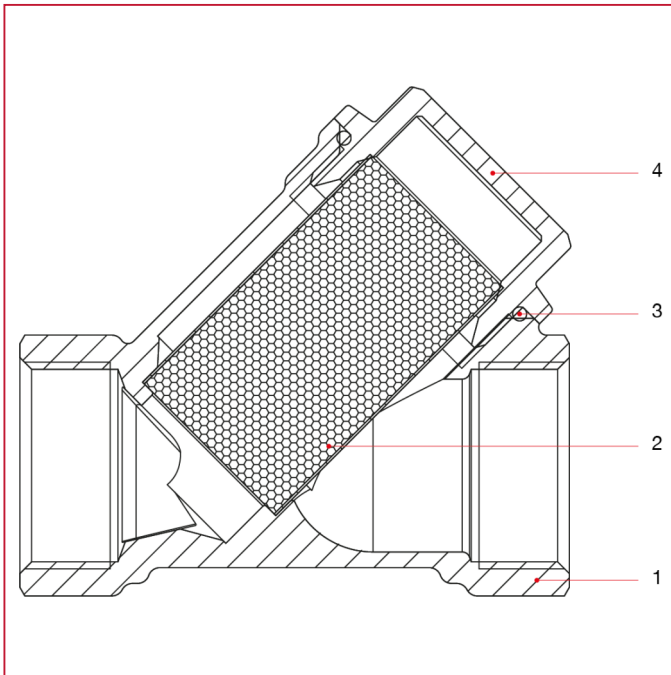

POS.	DESCRIPTION	N.	MATERIAL
1	Body	1	Nickel-plated brass CW617N
2	Strainer	1	Stainless steel AISI 304
3	O-ring	1	NBR
4	End adapter	1	Nickel-plated brass CW617N



# STRAINERS

## INSTRUCTIONS FOR INSTALLATION, MAINTENANCE AND USE - Y Strainer

### INSTALLATION

The Y strainer with metal mesh was designed to prevent solid impurities from entering pipes where they can build up and thus reduce the flow, resulting in greater head losses and oxidation-related problems.

The strainer must be installed upstream of all the system components that can get damaged or lose efficiency due to the presence of impurities.

It is advisable to install shut-off valves both upstream and downstream of the strainer, to facilitate the latter's maintenance.

The filter is normally installed on the inlet to the water supply line before the check valves and the pressure reducers.

For improved filtering efficiency and trapping of solid impurities, the filter body should be installed on horizontal pipes with the cap facing downwards.

For the installation normal hydraulic practices must be used, and especially:

- ones have to be sure that the two pipes are correctly aligned;
- if the fluid contains impurities (dirt, dust, excessive water hardness), these must be removed or filtered out. The hydraulic circuit must be clean;
- when making the plumbing connections, be careful to avoid excessive mechanical stress on the threading and/or fittings in general: over time these may break and cause leakages, which may damage objects and/or harm people;
- it is forbidden to use the device for any purpose other than its intended use;
- if the device is coupled with other components of the system, this must be done by taking into account the operating characteristics of both: incorrect coupling could jeopardise the operation of the device and/or system;
- make sure that the fluid flows in the direction of the arrow printed on the valve body.

### DISASSEMBLY

To deinstall the devices from the line or, nonetheless, before unscrewing the couplings connected to them:

- wear the protective clothing normally required for working with the fluid contained in the line;
- depressurize the line and operate in this way:
- during dismantling, apply the spanner to the end of the filter nearest to the pipe;

### MAINTENANCE

Impurity collectors require regular maintenance for cleaning the stainless steel filtering element and eliminating any impurities deposited inside the cap.

To perform these operations:

- carefully unscrew the blind cap;
- extract the stainless steel filter and clean it with water or compressed air;
- mount it back on by slotting it into the relevant cap housing for optimal positioning, taking care to ensure that the seal and/or O-ring between the body and the cap are properly positioned.

### WARNINGS

- 1 flow manifold in nickel-plated brass with flow meter
- all installations should be performed in accordance with existing local installation regulations and codes of practice where they exist;
- it is mandatory to follow the instructions supplied by the filter manufacturer and by the plant manufacturer, including those specifying how to properly position the filter connection.



## STRAINERS

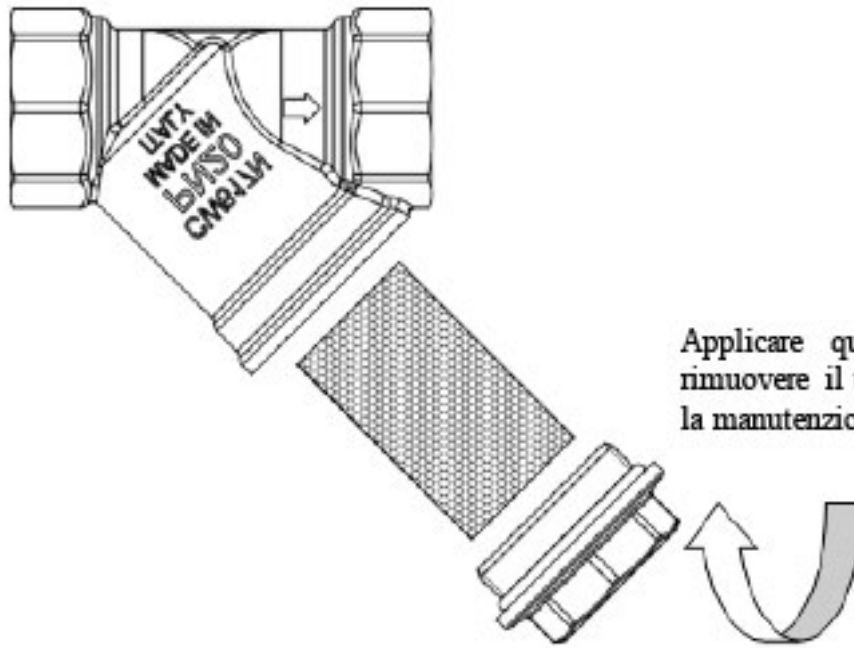



# STRAINERS

## LOSS DIAGRAM (With water)

	1/4"	3/8"	1/2"	3/4"	1"	1"1/4"	1"1/2"	2"
KV	2,20	3,40	3,80	7,20	11	13	15	28

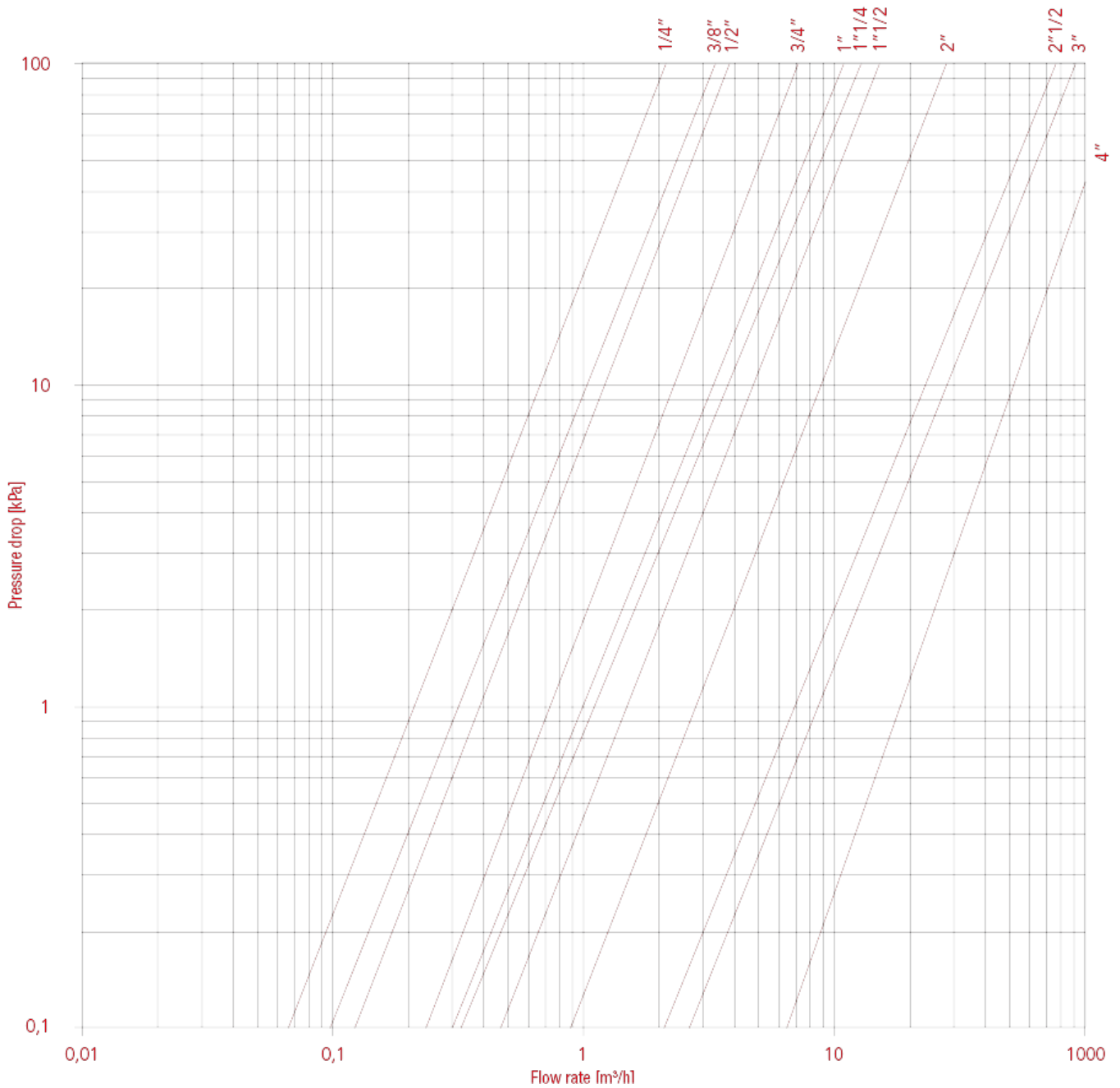





# STRAINERS

## PRESSURE-TEMPERATURE DIAGRAM

The values shown by the dropping lines state the maximum limit of employment of the valves.  
The shown values are approximate.

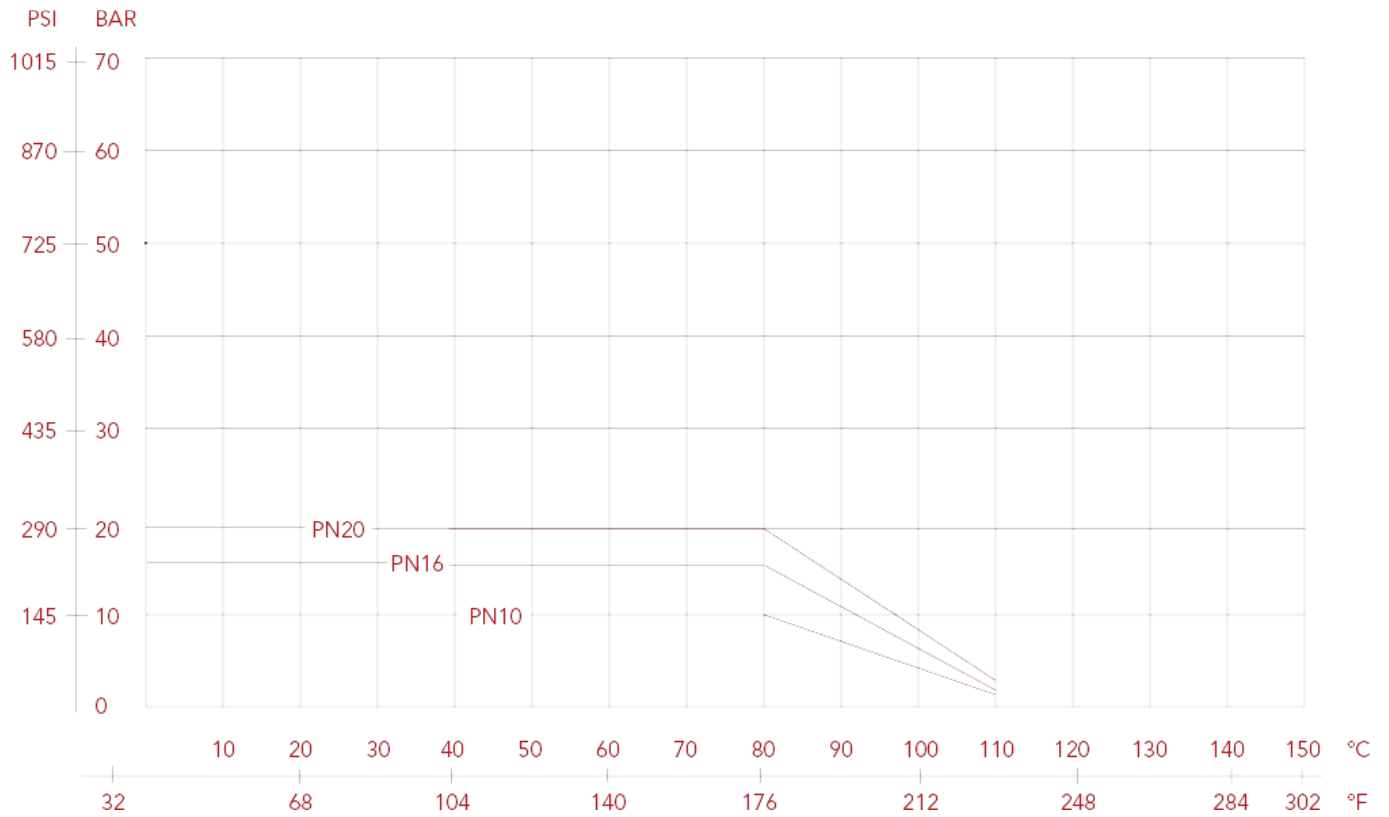



# STRAINERS

## 192CA Cartridge for Y strainer 193

### Y STRAINER



SIZE	CODE	PACKING	STRAINER
1/4" (DN 8)	192CA014GAS	1/0	1/4"
1/4" (DN 8)	192CA014GAS	1/0	3/8"
1/4" (DN 8)	192CA014GAS	1/0	1/2"
3/4" (DN 20)	192CA034GAS	1/0	3/4"
1" (DN 25)	192CA100GAS	1/0	1"
1"1/4 (DN 32)	192CA114GAS	1/0	1"1/4
1"1/2 (DN 40)	192CA112GAS	1/0	1"1/2
2" (DN 50)	192CA200GAS	1/0	2"

### TECHNICAL SPECIFICATIONS

Filtration degree: 50µm

### OVERALL DIMENSIONS

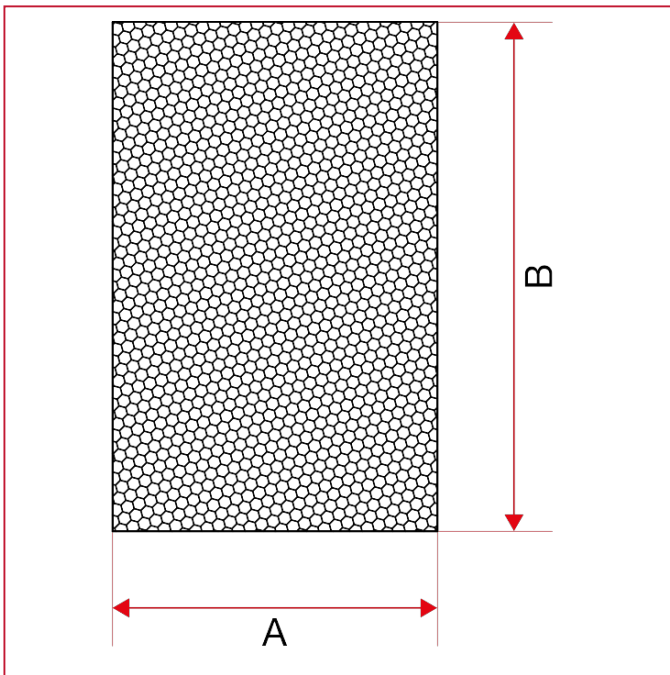

	1/4"	1/4"	1/4"	3/4"	1"	1"1/4	1"1/2	2"
DN	8	8	8	20	25	32	40	50
A	18	18	18	24	30	36	42	53
B	32	32	32	41	47	50	57	70



# STRAINERS

## MATERIALS

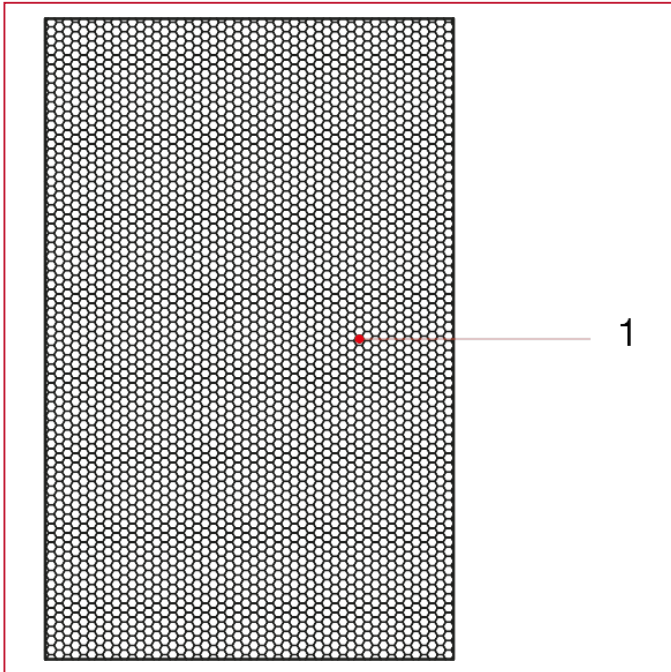

POS.	DESCRIPTION	N.	MATERIAL
1	Cartridge	1	Stainless steel AISI 304



# STRAINERS

## 189 Self-cleaning strainer

Suitable for domestic water services, heating and air-conditioning plants, compressed air systems.

Supplied with an extractable straining cartridge, double pressure gauge and hose cock to dump the impurities.

SELF-CLEANING STRAINER



SIZE	PRESSURE	CODE	PACKING
1/2" (DN 15)	16bar/232psi	1890012	1/6
3/4" (DN 20)	16bar/232psi	1890034	1/6
1" (DN 25)	16bar/232psi	1890100	1/4
1"1/4 (DN 32)	16bar/232psi	1890114	1/4
1"1/2 (DN 40)	16bar/232psi	1890112	1/4
2" (DN 50)	16bar/232psi	1890200	1/4

### CERTIFICATIONS



### TECHNICAL SPECIFICATIONS

Body in nickel-plated brass.

Minimum and maximum working temperatures: 0°C, 100°C in absence of steam.

Threads: ISO 228 (equivalent to DIN EN ISO 228 and BS EN ISO 228).

Filtration degree: 300µm.

### OVERALL DIMENSIONS

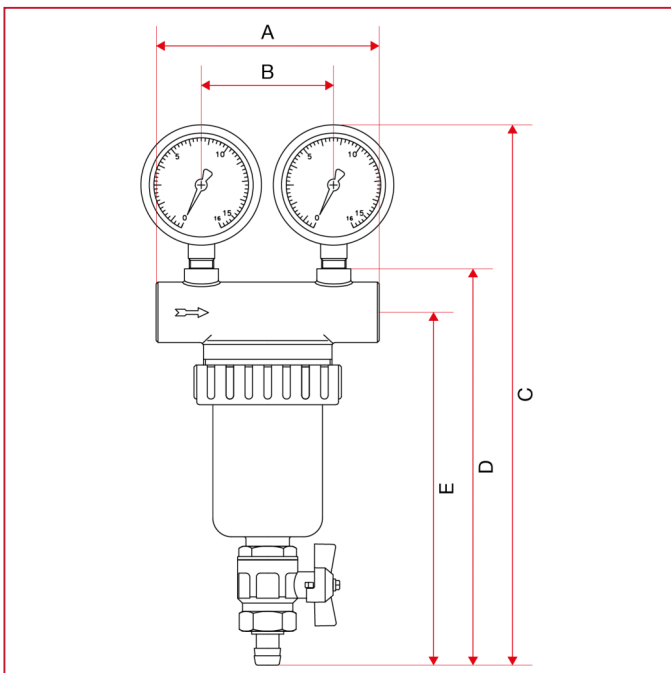



# STRAINERS

	1/2"	3/4"	1"	1"1/4	1"1/2	2"
A	118	118	123	123	153	153
B	70	70	72	72	98	98
C	272	272	302	302	342	342
D	208	208	234	234	272	272
E	187	187	202	202	236	236
Kg/cm <sup>2</sup> bar	16	16	16	16	16	16
LBS - psi	232	232	232	232	232	232

## MATERIALS

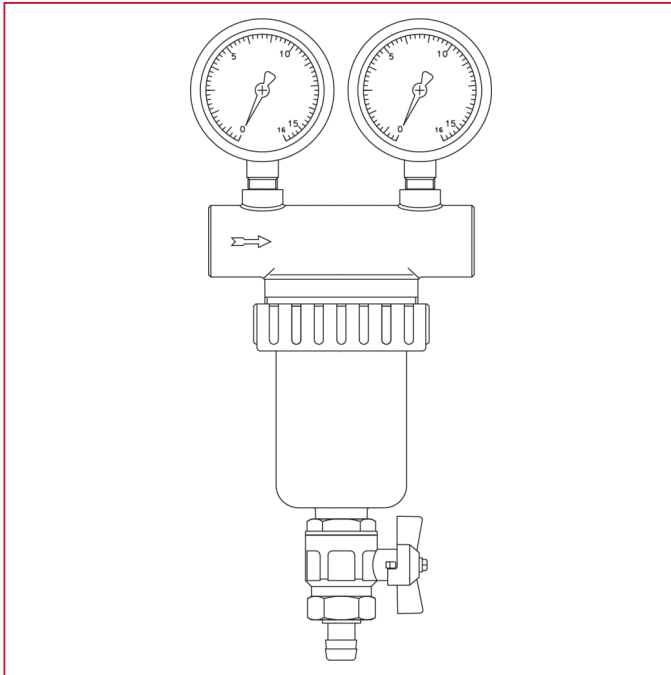

POS.	DESCRIPTION	N.	MATERIAL
1	Body	1	Nickel-plated brass CB735S
2	Nut	1	Nickel-plated brass CW617N
3	Cartridge	1	Stainless steel AISI 304
4	Cartridge seats	1	NBR
5	O-ring	1	NBR
6	Plastic parts	1	Ultramid®



# STRAINERS

## LOSS DIAGRAM (With water)

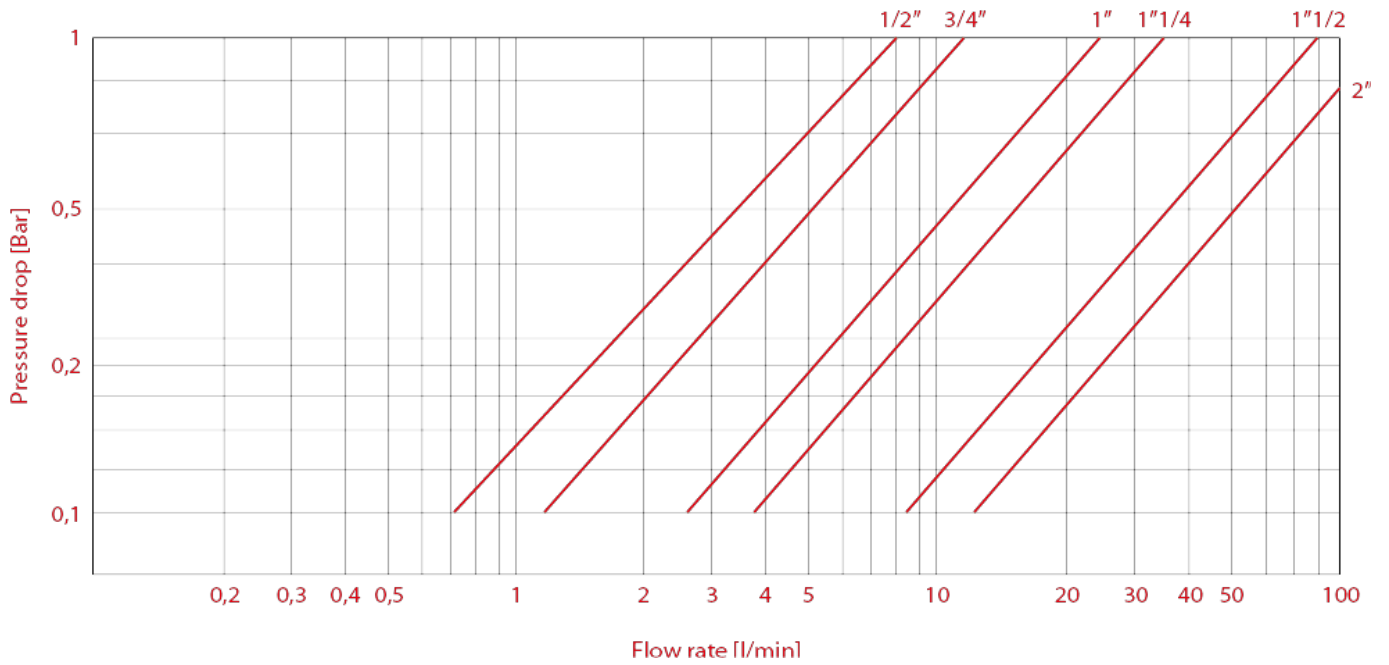



# STRAINERS

## 189CA Cartridge for self-cleaning strainer

### SELF-CLEANING STRAINER



SIZE	CODE	PACKING
1/2" (DN 15)	189CA012	1/0
3/4" (DN 20)	189CA034	1/0
1" (DN 25)	189CA100	1/0
1"1/4 (DN 32)	189CA114	1/0
1"1/2 (DN 40)	189CA112	1/0
2" (DN 50)	189CA200	1/0

### TECHNICAL SPECIFICATIONS

Filtration degree: 300µm.

### OVERALL DIMENSIONS

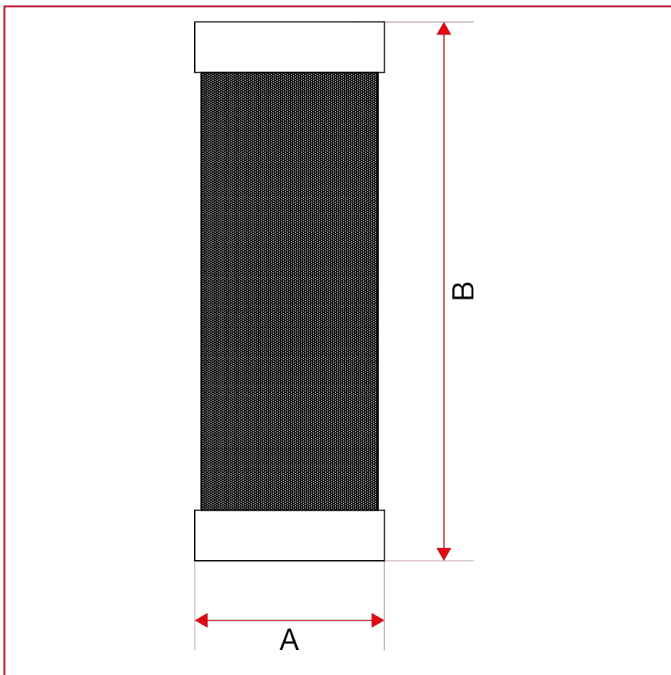

	1/2"	3/4"	1"	1"1/4	1"1/2	2"
A	34	34	42	42	46	46
B	100	100	108	108	128	128



# STRAINERS

## MATERIALS

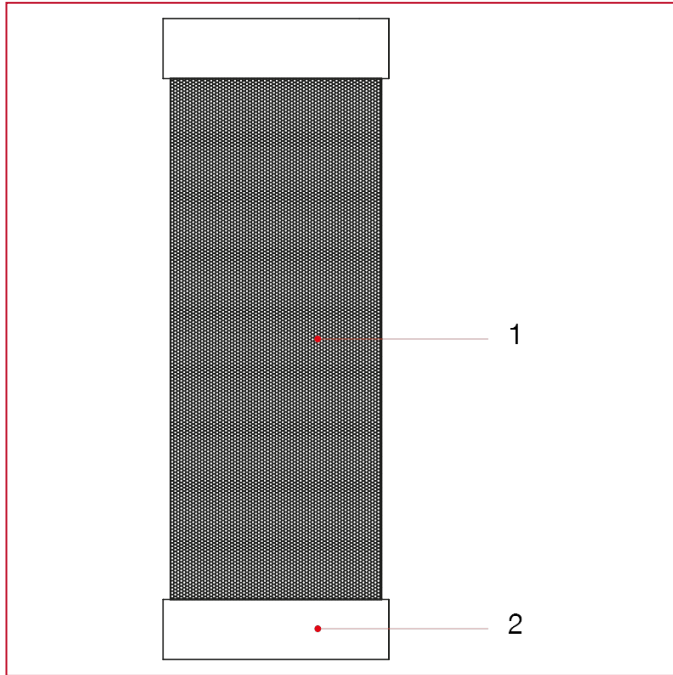

POS.	DESCRIPTION	N.	MATERIAL
1	Cartridge	1	Stainless steel AISI 304
2	End ring	2	NBR





**ITAP S.p.A.**  
Via Ruca 19  
25065 Lumezzane  
Brescia (ITALY)  
Tel 030 8927011  
Fax 030 8921990  
[www.itap.it](http://www.itap.it) - [info@itap.it](mailto:info@itap.it)

We reserve the right to make improvements and changes to the products described herein and to the relative technical data, at any time and without forewarning.

rev. 20220330