

WAVIN TIGRIS
Technical Handbook

Tigris family one-fits-all



Wavin

Contents

1. Tigris technical handbook	page 4
1.1 The one-pipe-fits all Tigris product family	page 5
1.2 Tigris Multi-layer pipe – key features	
1.2.1 The Wavin multi-layer composite pipe for drinking water applications	page 6
1.2.2 The Wavin multi-layer composite pipe for underfloor heating applications	page 7
1.3 The Radial Press-Fit system explained	
1.4 The Push-Fit system explained	page 8
1.5 The Tigris product family at a glance	page 9
2. Tigris fitting- product features	page 10
2.1 Fitting design K5/ M5	page 10
2.2 Fitting design K1/ M1	page 14
2.3 Fitting design smartFIX	page 16
2.4 Product matrix with benefits	page 17
2.5 Tigris feature explanation	page 18
2.6 Warranty (Adapt eventual to country specific)	page 19
3. Installation Instructions	page 22
3.1 Overall installation instructions	page 22
3.2 A quick guide to get started	page 22
3.3 Detailed installation instructions	page 24
3.3.1 Making a press-fit connection	page 24
3.3.2 Pipe bending	page 27
3.3.3 Tigris M5 Metal Connector: Assembly instructions	page 28
3.3.4 smartFIX push-fit transition to copper	page 28
3.3.5 Repair Couplers	page 29
3.3.6 Threaded fittings	page 30
3.4 General guidelines for handling and storage	page 31
3.5 Finalizing the installation; leak and pressure tests and flushing	page 33
3.5.1 Pressure tests (Defined Leak & Leak Alert)	page 33
3.5.2 Function check with water- Defined Leak	page 33
3.5.3 Function check with air- Acoustic Leak Alert	page 34
3.5.4 Flushing	page 35
3.5.5 Initial operation and handover	page 36
3.5.6 Usage of the Wavin Tigris pressure test plug	page 36
3.5.7 Protocol pressure test for drinking water installations	page 37
3.5.8 Pressure test for radiator installations in accordance with DIN 18380	page 39
3.6 Linear expansion and fixing	page 41
3.6.1 Basics	page 41
3.6.2 Consideration of thermally induced linear expansion	page 41
3.6.3 Absorption of length changes by bending joints	page 42
3.6.4 Fixing intervals	page 43
3.7 Concealed installations	page 44
3.7.1 Pipes in screed or concrete	page 44
3.7.2 Pipes in the floor construction	page 44
3.7.3 Pipelines installed under plaster	page 45
3.7.4 Pipelines installed in exposed locations	page 45

3.8.	Installation examples	page 46
3.8.1.	Installation variants for drinking water	page 46
3.8.1.1.	Single Tee installation	page 46
3.8.1.2.	In series installation	page 47
3.8.1.3.	Loop installation	page 48
3.8.1.4.	Loop installation with circulation connection	page 49
3.8.1.5.	Internal circulation	page 50
3.8.2.	Heating installation Variants	page 51
3.8.3.	Radiator connection: installation Variants	page 52
3.8.3.1.	Compact Radiators	page 52
3.8.3.2.	Valve Radiators	page 53
4.	Technical information	page 54
4.1	Technical specifications	page 54
4.1.1.	Technical specifications MP Pipes	page 54
4.1.2.	Technical specifications Fittings	page 55
4.1.3.	Classification of operating requirements for Wavin Multi layer pipes	page 57
4.2	Flow performance	page 58
4.2.1	Zeta values Tigris M5 & Tigris K5	page 59
4.2.2	Zeta values Tigris M1 & Tigris K1	page 60
4.2.3	Pressure loss in pipes for drinking water applications	page 61
4.2.4	Pressure loss in heating systems	page 63
4.3	Pressing Tools	page 68
4.3.1	Wavin pressing jaws and alternative brand pressing profiles	page 68
4.3.2	Cordless and electric press tools	page 69
4.3.3	Overview of compatible press tools	page 70
5	Use of chemicals	page 72
5.1	Disinfection of drinking water pipelines	page 72
5.2	Thermal Disinfection	page 72
5.3	Chemical Disinfection	page 73
5.4.	List of allowed chemicals	page 73
6	Certifications	page 74
7	Local Regulations	page 75
8	Product portfolio	page 76
8.1	Product portfolio M5 & M1	page 76
8.2	Product portfolio K5 & K1	page 78
8.3	Product portfolio on SKU level	page 79

Contents



Tigris technical handbook

This handbook will guide you on the specific characteristics of each member of the Tigris product family, explain the benefits and application field, provide assembly instructions and technical background, norms and regulations. Finally, you will find the assortment overview on product level.

For more information or personal advice, please contact your local sales representative or visit wavin.com.

1. Tigris family

- one-pipe-fits-all

1.1. The one-pipe-fits-all Tigris product family

With Tigris, Wavin offers a complete program of pipe and fitting solutions for multi-layer composite pipe systems. The Tigris family has 5 fitting solutions that are all perfectly designed to offer the most reliable connection for the Wavin's multilayer composite pipe, dedicated to the requirements of each specific field of application.

The core of the fitting program is based on the reliable Radial Press-Fit technology, offering a complete PPSU line with Tigris K5 and Tigris K1 or brass line with Tigris M5 and Tigris M1. The fitting program is completed with Tigris smartFIX, a PPSU fitting range based on Push-Fit technology.

All Tigris fitting lines fulfil the specific requirements for hot and cold water installations and radiator heating and underfloor heating systems. They meet all drinking water quality requirements and are physiologically harmless.

Being a real product family, all fittings fit to the same multilayer composite pipe, offering a 1-fits-all solution!

1.2. Tigris Multi-layer pipe – key features

The Wavin multi-layer composite pipes (MP) comprise either an internal layer of cross-linked polyethylene (PE-Xc) or PE with raised temperature resistance (PE-RT)¹⁾, an external protection layer in HD-PE and an intermediate butt welded aluminium layer. These layers are uniformly connected by means of bonding agents. This produces a pipe structure with a total of five layers.

Multilayer composite pipes offer many advantages

- ⦿ Dimensional stability, resistant to unwanted movement yet flexible to work with
- ⦿ Limited linear expansion, comparable to copper, thanks to the aluminium layer
- ⦿ Significant lower demand of fittings due to ease of pipe bending
- ⦿ Perfect for tight installation situations due to easy bending
- ⦿ Pipe holds its shape after bending thanks to the aluminium layer
- ⦿ Corrosion resistant, free of encrustation
- ⦿ Diffusion-proof

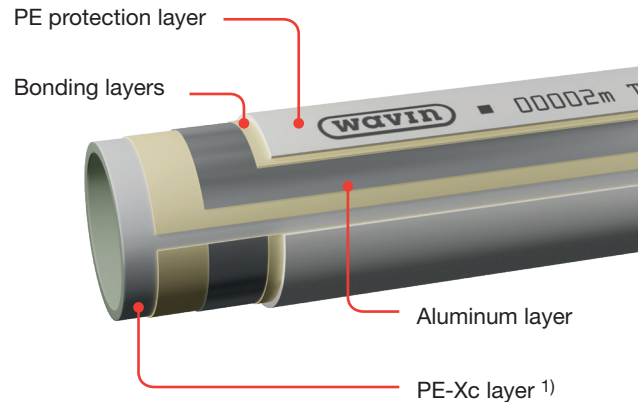

Fig. 1: Multi-layer composite pipe structure.

Specific benefits of Wavin multilayer pipes

- ⦿ Big inner diameter for an optimal flow performance
- ⦿ Wide field of applications, drinking water as well as heating systems
- ⦿ Suitable for all kind of water qualities
- ⦿ High pressure, temperature and chemical resistance.
- ⦿ Butt-weld aluminium layer; uniform thickness and resistance to peeling apart
- ⦿ Physiologically harmless
- ⦿ Low weight
- ⦿ Quick and safe assembly
- ⦿ On coils and straight lengths
- ⦿ Pre-insulated or with protection pipe
- ⦿ Easy to cut and easy to bend
- ⦿ Broad range of dimensions (14 mm to 75 mm)

The Wavin multilayer composite pipes can be handled by a single installer. An optimal aluminium thickness means it can be bent by hand or supported by bending springs and bending pliers.

The Wavin multilayer composite pipes are classified by the kind of application according to ISO 21003. Please see the chapter Technical specifications MP Pipes for detailed information.

¹⁾ PE-Xc available in the range 16 to 63 mm,
PE-RT available in 16, 20 and 75 mm

PE-Xc is a reinforced physical (electron-beam) cross-linked polyethylene. Due to the cross-linking, the PE is not fusible and has a high thermal stability that especially predestines it for drinking water installations and high temperature radiator connections. The physical cross-linking ensures an equal spread of the links and an environmental and drinking water quality friendly cross-linking without any addition of chemicals.

PE-Xc is typically chosen when more extreme conditions are applied, like chemical or thermal disinfection.

PE-RT is a raised-temperature resistant reinforced polyethylene that also shows a higher temperature resistance than standard PE but below the level of PE-Xc. This makes it especially suitable for underfloor heating applications and low-temperature radiator connections.

See the technical chapter 5 for an overview of released chemicals.

1.2.1. The Wavin multi-layer composite pipe for drinking water applications

The white coloured Wavin multilayer pipes can be applied for hot & cold water installation as well as heating systems. The pipes meet all drinking water quality requirements and are physiologically harmless. They also are oxygen tight and fulfil the requirements for low temperature radiator connections and underfloor heating systems.

Depending on the pipe dimension, they have an inner layer material in PE-Xc or PE-RT, an external layer in HDPE with an aluminium layer in between connected by special bonding agents.

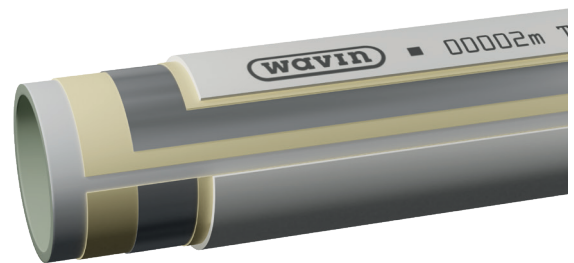

Fig. 2: Multi-layer composite pipe for multiple applications.

The Wavin Tigris pipe family contains 2 core ranges of multilayer pipes, dedicated to their application.

- ⊕ Wavin White - drinking water applications
- ⊕ Wavin Blue - underfloor heating applications

The Wavin multi-layer composite pipe for drinking water applications fulfils the requirements according to ISO 21003 and carries amongst others DVGW, KIWA and KOMO certifications.

Please see the chapter Technical specifications MP Pipes for detailed information.

1.2.2. The Wavin multi-layer composite pipe for underfloor heating applications

The blue coloured Wavin multilayer pipes can be applied for radiator connection and underfloor heating. They are designed for lower temperature systems, are oxygen tight and fulfil the requirements for low temperature radiator connections and underfloor heating systems.

They have an inner layer material PE-RT, an external layer in HDPE with an aluminium layer in between connected by special bonding agents.

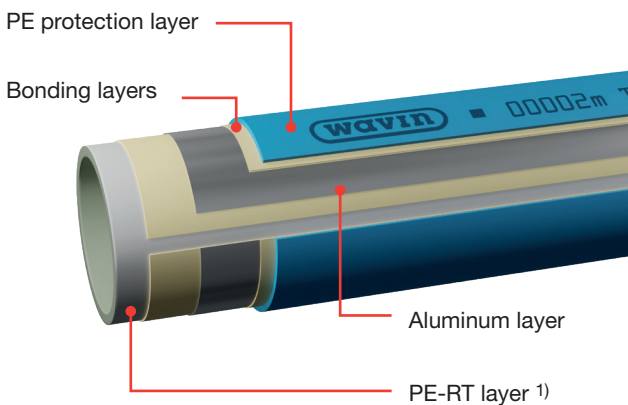

Fig. 3: Multi-layer composite pipe for underfloor heating.

The Wavin multi-layer composite pipe for underfloor heating applications fulfils the requirements according to ISO 21003.

Please see the chapter Technical specifications MP Pipes for detailed information.

¹⁾ PE-Xc available in the range 16 to 63 mm,
PE-RT available in 16, 20 and 75 mm

1.3. The Radial Press-Fit system explained

Radial Press-Fit fittings are typically designed for making a fast, reliable and durable connection with multilayer pipes. The principle is based on deforming the metal cap of the fitting with a pressing tool which creates a tight sealing and mechanical connection at the same time in just one pressing. As the cap is deformed in a radial direction related to the pipe, it is called a Radial Press-Fit system.



Fig. 4: Tigris Radial Press-Fit pressing.

The Radial Press-Fit system offers a lot of benefits compared to alternative connection methods for piping.

It is a very fast way of making a durable, reliable connection; just cut the pipe, stick the fitting* on the pipe and press. Ready!

Because it is a predefined process and the Wavin fittings are designed to prevent every conceivable installation mistake, the result is a reliable and durable connection. In addition, Wavin Tigris fittings are designed and tested even beyond the high requirements for a 50-year lifetime simulation. The Wavin system warranty ensures a long and trouble-free lifetime.

Tigris Radial Press-Fit fittings are subjected to constant internal quality controls and continuous external monitoring. They are certified by DVGW and tested according to EN-ISO 21003.

^{*}) depending on fitting type, see chapter 3- Installation Instructions

The Radial Press-Fit system can cover a wide range of diameters, making it a suitable piping system for all kind of applications. Just small domestic housing project or big utility projects, risers and floor distribution, for heating as well as potable water systems.

Speed, reliability, variety; the Wavin Tigris Radial Press-Fit system covers it all.

*) depending on fitting type, see chapter 3 Installation Instructions for installation details

1.4. The Push-Fit system explained

Designed for a fast and reliable connection of pipes Push-fit fittings are the logical further development of the well-known

and proven press-fit fittings. As a Push-Fit fitting system Wavin smartFIX stands out for a quick, press-tool-free processing: One plumber, one process is the claim leading its development. Wavin smartFIX is suitable for hot and cold-water installations and heating applications in residential construction as well as in public and commercial buildings.

The key benefits of Push-Fit solutions are the speed of installation and savings in time. A Push-Fit fitting can be mounted within a few seconds. Just push the pipe in the fitting, ready. Tools are just needed for cutting and calibrating the pipe.

Especially in narrow places, where there is not enough room for pressing the fitting, push-fit fittings ensure safe and reliable connections.

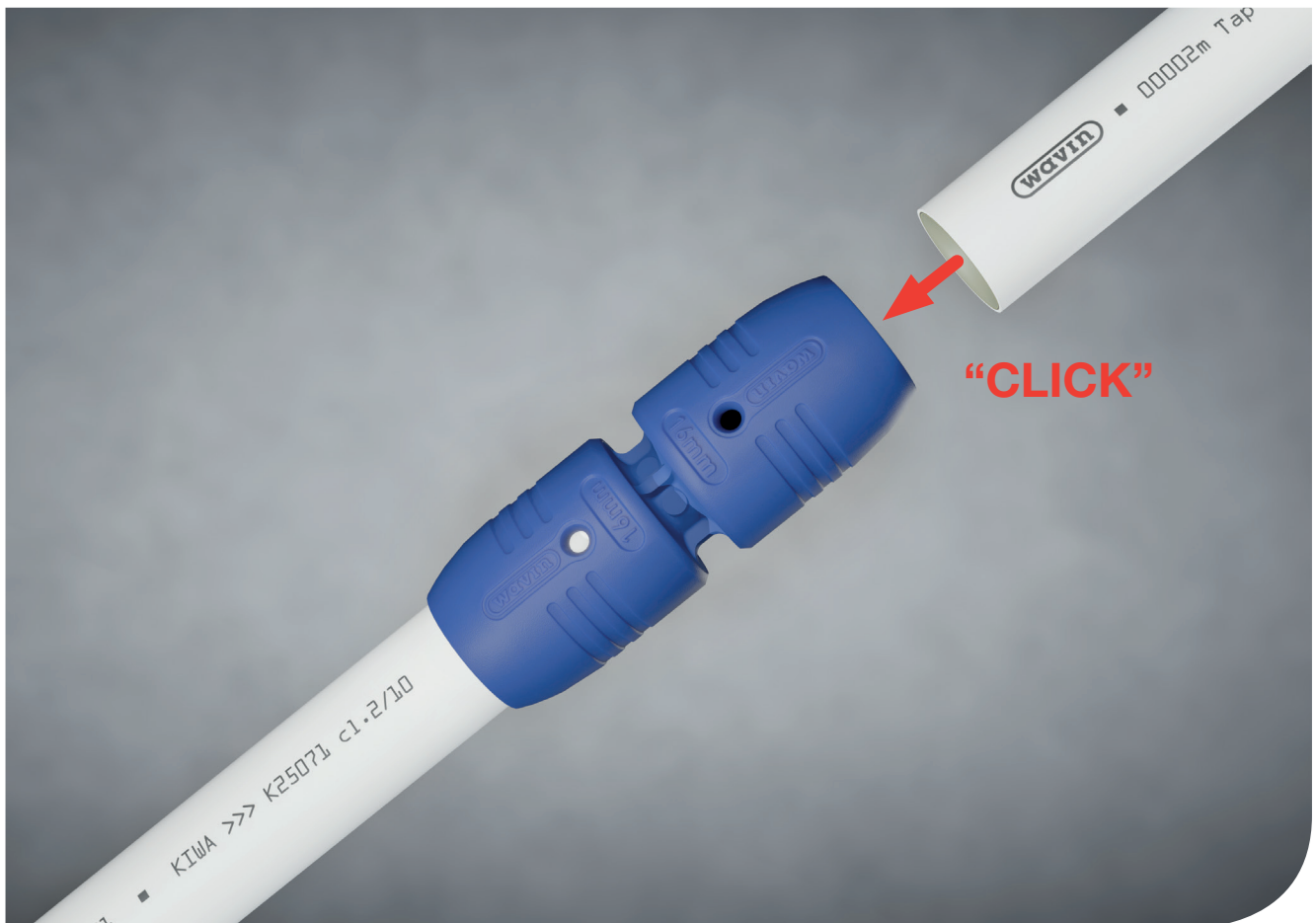
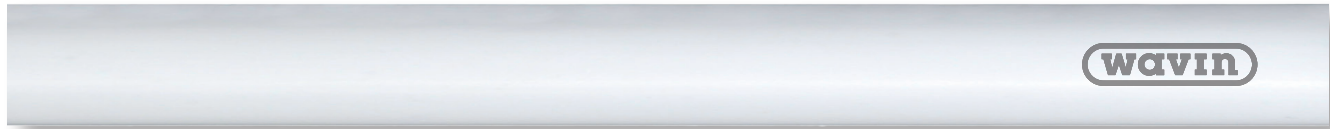

Fig. 5: Tigris smartFIX push-fit connection.

1.5. The Tigris product family at a glance



one pipe fits all

PPSU series			Brass series	
Push-Fit	Radial Press-Fit		Radial Press-Fit	
				
Tigris smartFIX 16-25 mm	Tigris K5 16-40 mm	Tigris K1 50-75 mm	Tigris M5 16-40 mm	Tigris M1 50-75 mm

2. Tigris fitting

product features

The press fitting program of Tigris offers 2 core lines based on your preferred choice of body material.

Wavin Tigris K5 and Tigris K1 are press fittings with bodies made of the high technical performance plastic Polyphenylsulfone (PPSU). On top, the PPSU program offers a Push-Fit solution; Tigris smartFIX.

Wavin Tigris M5 and Tigris M1 are metal press fittings with bodies made of UBA listed drinking water approved brass materials.

Both Radial Press-Fit, in PPSU or brass, cover a complete range of fittings that fit up to 75 mm multi-layer composite pipes.

Tigris K5 and Tigris M5 cover the range from 16 (14 NL) up to 40 mm. Tigris K1 and Tigris M1 cover the range from 50 to 75 mm. Tigris smartFIX covers the range 16 to 25mm.

2.1. Fitting design K5/ M5

Based on the proven design of Tigris Radial Press-Fit technology, the 5-series offer a rich range of fittings with the latest technology that lead to an outstanding reliable fitting with significant increase flow performance and the unique Acoustic Leak Alert technology. The fittings are equipped with a stainless-steel press sleeve, that gives additional strength and reliability to the system and that is designed for multiple pressing jaw systems. The Tigris K5/M5 are available in 16-40 mm.

About PPSU

PPSU (Polyphenylsulfone) is a high technical performance plastic which is resistant to corrosion, encrustation and high temperatures (heat shape resistance > 200 °C, processing temperature 360°C).

It's extremely high notched impact strength and lack of sensitivity to stress cracks make the Tigris K5, Tigris K1 and Tigris-smartFIX fitting extremely robust and insensitive to impacts.

The performance of PPSU has already been proven over many years in aircraft engineering, medical sterilization technology, chemical plants and automotive engineering as well as in Wavin plumbing fittings. In addition all female-threaded fittings are reinforced with high quality threaded inserts to ensure an extremely robust performance. With Ecobrass inserts, our PPSU fittings are

extremely well suited for environments where the highest water quality standards are required. All brass inserts of Wavin PPSU fittings are made of Ecobrass CW 724R, a UBA listed brass quality that is dezincification resistant (DZR) and lead-free.

About brass

The brass fittings are made from the UBA listed drinking water approved brass type CW 617N with low lead content (< 2%).

This widely accepted brass can be used for all applications, heating as well as potable water and like PPSU, it resists high temperatures and pressures and is extremely robust and insensitive to impacts.

OPTIFLOW

Reliability is a key requirement to ensure lifetime performance, but also reducing pressure loss to a minimum defines the quality and performance of the installation. Designed specifically to deliver optimal flow performance, the 5-series of Tigris with OPTI FLOW have up to a 50% larger inner bore. This is especially relevant for the smaller pipe diameters where the impact of inner bore on pressure loss is the biggest. As a result, your customers will enjoy a higher total system performance. When it comes to optimal flow performance, Tigris K5 and Tigris M5 are the fittings of your choice.

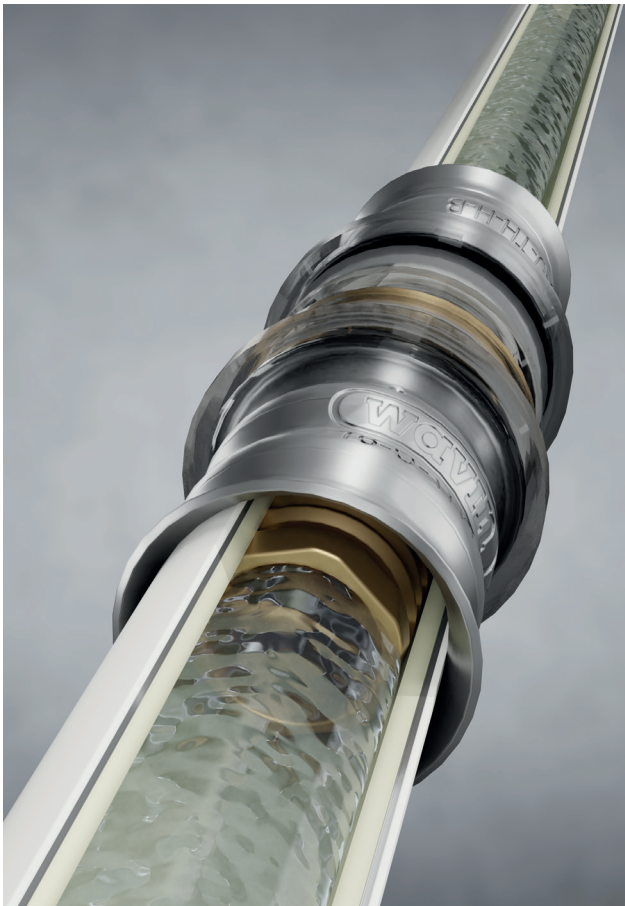

*Fig. 6: OPTIFLOW.
Optimal flow performance.*

MULTI JAW

With MULTI JAW, Tigris K5 and Tigris M5 guarantees secure connections regardless of the profile. You can use all of the most common jaw profiles to press the new Tigris K5 or Tigris M5 as they are compatible with U, Up, H, TH and B profiles. This eliminates the need to buy new equipment and makes it easy to switch to the new Tigris M5 or Tigris K5 without worrying about your system warranty.

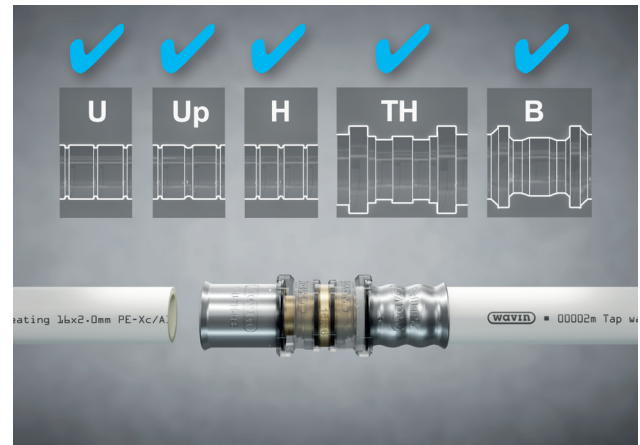

*Fig. 7: MULTIJAW.
Pressing possible with the most common pressing profiles.
Wavin System Warranty.*

Leak prevention

Creating a reliable installation is the key aim for every installer and a hygienic system is essential for every drinking water application. To check if the installation is made leak tight there are 2 options: pressurize the installation with water or with air².

2) Details about test procedures with air or water can be found in chapter 3.5.

DEFINED LEAK-Testing with water

When the pressure test is executed with water, the Defined Leak feature guarantees that an accidentally forgotten unpressed connection is clearly exposed to the installer by visually leaking during the pressure test.

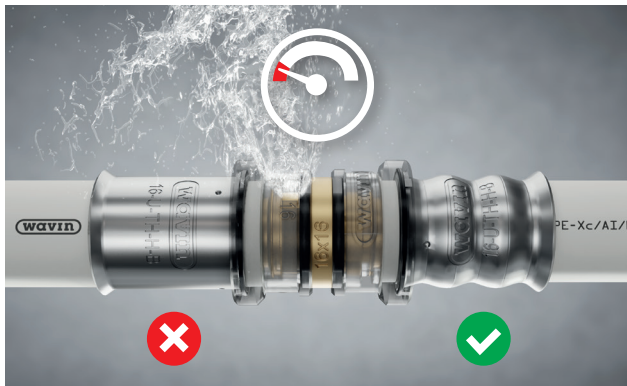

Fig. 8: DEFINED LEAK in the pressure test reveals with leaking water the unpressed fitting.

NEW: ACOUSTIC LEAK ALERT-testing with air!

From a hygiene perspective executing the pressure test with air instead of water might be preferable or even obligatory. However, with Defined Leak alone, an unpressed fitting might be hard to locate on an air test. Therefore Tigris M5 and Tigris K5 are equipped with **Acoustic Leak Alert**. When executing a pressure test with air, this feature enables installers to trace an entire system for leaks caused by connections that have not been pressed.

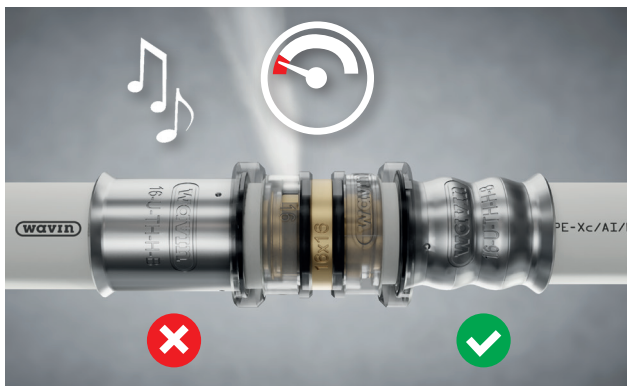

Fig. 9: ACOUSTIC LEAK ALERT. A loud whistle tone caused by the leaking air helps to trace the unpressed fitting.

With ACOUSTIC LEAK ALERT any un-pressed fitting emits a loud whistle ($\pm 80 \text{ dB(A)}$)³⁾, making locating the source of the leak extremely easy. And, because unpressed fittings are detected so quickly, Tigris M5 and Tigris K5 fittings make testing with air an unbelievably attractive alternative.

Using air instead of water for pressure tests avoids stagnating water in the installation – impressively eliminating Legionella risks. On top of that, testing with air prevents frost damage during winter months.

Tigris K5 and Tigris M5 featuring Acoustic Leak Alert still feature Defined Leak. This means no matter what is used, water or air, an unpressed fitting can always easily be found.

IN4SURE™

In order to make a reliable pressing, it is important that the pipe is properly inserted into the fitting. The IN4SURE™ feature offers a visual check if the pipe is inserted far enough. The transparent fixing of Tigris K5 and M5 offers a 360° visual check. This is extremely helpful in difficult access applications. When the pipe is visible, you are ready to press.

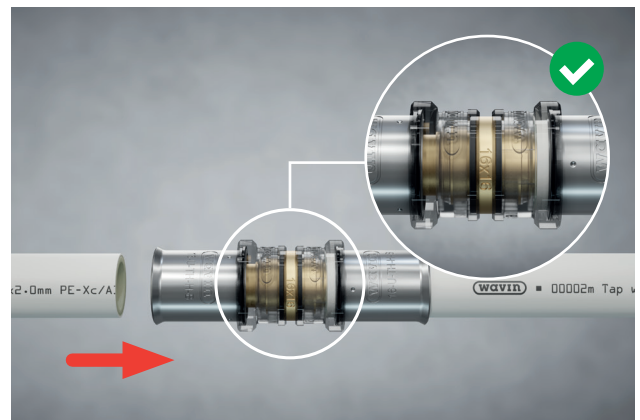

Fig.10: IN4SURE™ helps to check if the pipe is inserted properly.

³⁾ At noise levels from 80 dB(A), long-term exposure may cause hearing damage and hearing protection is therefore recommended. Be aware that covering the fitting with (thermal) insulation can reduce the sound level.

Chamfer Free

With the Tigris 5 series it is no longer required to chamfer the pipe after cutting it on the desired length. Just cut the pipe square and insert the pipe into the fitting.



Fig.11: No chamfering needed for Tigris K5 and Tigris M5.

EASYFIT

The fittings are designed in a way that pipe is guided onto the sleeve in a straight way and that the O-rings are protected against damage during pipe insertion. The patented hexagonal sleeve-end enables low insertion force, but of course calibration is still allowed if you want to reduce insertion forces further. But if you forget, a reliable connection is still guaranteed.

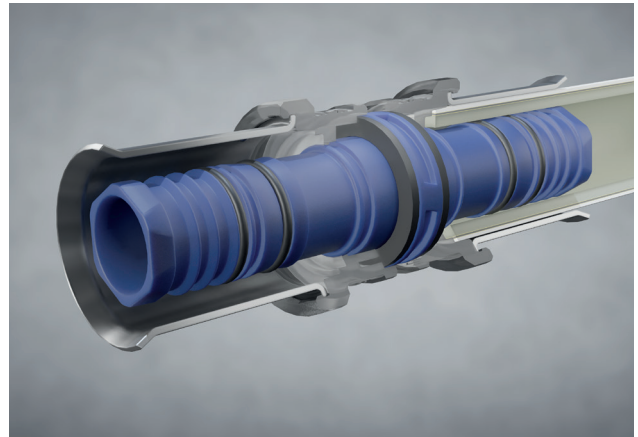

Fig.12: EASYFIT pipe insertion without calibration.

ULTRASEAL

The Tigris fittings have been designed to ensure a long lifetime, problem free operation and durable sealing. This is established by O-rings of the highest quality EPDM materials that resist high temperatures and have high chemical resistance. They have been exposed in the lifetime simulation test to extreme conditions that are even beyond the ISO standards in order to ensure the utmost reliable sealing possible; ULTRASEAL.

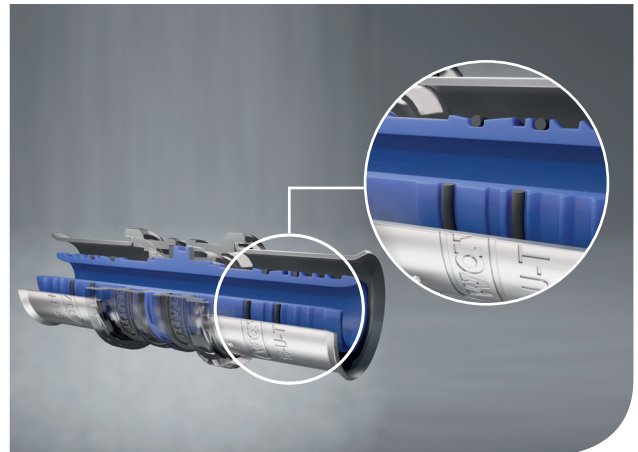

Fig.13: ULTRASEAL O-rings have been tested even beyond the ISO requirements for life test simulation

PIPEGRIP

For a reliable pressing a proper pipe insertion is essential. To ensure that the pipe stays in place whilst not pressed, the caps on the fittings have small dents that firmly hold the fitting and pipe in position. They even hold a pipe weight up to 2 m length. This means that no additional hands are needed to keep the pipe in position and the free hand can be used to operate the pressing tool.



Fig. 14: PIPEGRIP firmly holds the pipe in position to have free hands for operating the pressing machine.

2.2. Fitting design K1/ M1

The Tigris K1 and Tigris M1 fittings, with patented hexagonal head cross-section, are well known by their many years of proven reliability. The fittings are equipped with a stainless-steel press sleeve, that gives additional strength and reliability to the system. The Tigris K1/M1 fittings have to be pressed with a U-and Up profile. The pipe must be calibrated before pushing into the fitting.

The fittings are suitable for hot and cold-water applications and heating systems. The Tigris K1/M1 fittings are available in 50-75 mm.

IN4SURE™

In order to make a reliable pressing, it is important that the pipe is properly inserted into the fitting. The IN4SURE™ feature offer a visual check if the pipe is inserted far enough. The fittings have two observation windows, through which the insert depth of the pipe can be reliably checked before pressing. If the pipe is visible, a reliable pressing can be made.

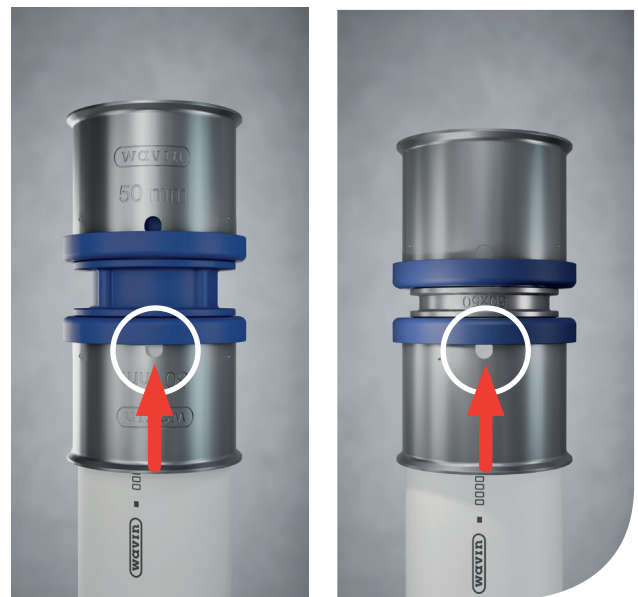

Fig. 15: IN4SURE™ helps to check if the pipe is inserted properly.

DEFINED LEAK-Testing with water

When the pressure test is executed with water, the Defined Leak feature guarantees that an accidentally forgotten unpressed connection is clearly exposed to the installer by visually leaking during the pressure test.



Fig.16: DEFINED LEAK in the pressure test reveals with leaking water the unpressed fitting.

LOW INSERTION FORCES

The patented hexagonal head cross-section has a positive impact on reducing the insertion forces which reduces the force required to insert the pipe. The sleeve is designed for an optimal guidance of the pipe during insertion, whilst eliminating the risk of damaging the O-rings during installation.

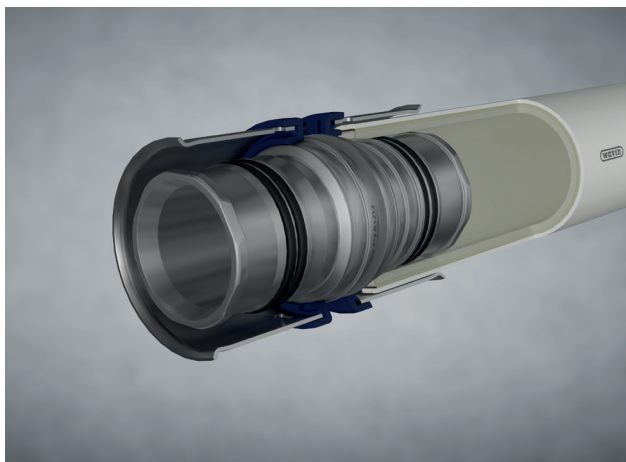

Fig. 17: Low insertion force thanks to the patented hexagonal sleeve-end.

PIPEGRIP

For a reliable pressing a proper pipe insertion is essential. To ensure that the pipe stays in place before being pressed, the caps on the fittings have small dents that firmly hold the fitting and pipe in position. They even hold a pipe weight up to 2 m length. This means that no additional hands are needed to keep the pipe in position and the free hand can be used to operate the pressing tool.



Fig.18: PIPEGRIP firmly holds the pipe in position to have free hands for operating the pressing machine.

Besides these outstanding features, the fittings provide further advantages in practise:

- ⦿ Possible to combine with Tigris K5, Tigris M5 and smart-FIX in one installation
- ⦿ Dimensions from 50 mm to 75 mm to complete the Wavin MP range
- ⦿ Quick and safe assembly
- ⦿ Physiologically harmless

2.3. Fitting design smartFIX

The Tigris smartFIX system is a fast and reliable solution that ensures that an installation can easily be done without pressing tools. Just Cut Chamfer Connect. That's it.

Reliable in all aspects

Via two visual check windows in the cap it can be checked if the pipe is inserted to the stop. The sealing is done via a dry-coated O-ring, which contributes to minimising the insertion forces. The design of the fitting is the key to the functionality. A spring-loaded grab ring automatically brings the pipe in the right position when it is pushed in. It grabs the pipe twice, on the inside, once on the outside and ensures a reliable longitudinally force-locked connection. The insertion depth of the pipe can be checked visually by a window in the cap. When the pipe is visible through the window, a reliable connection is ensured.

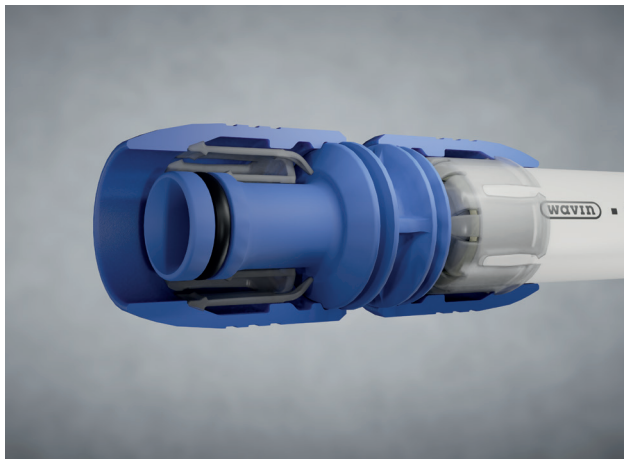
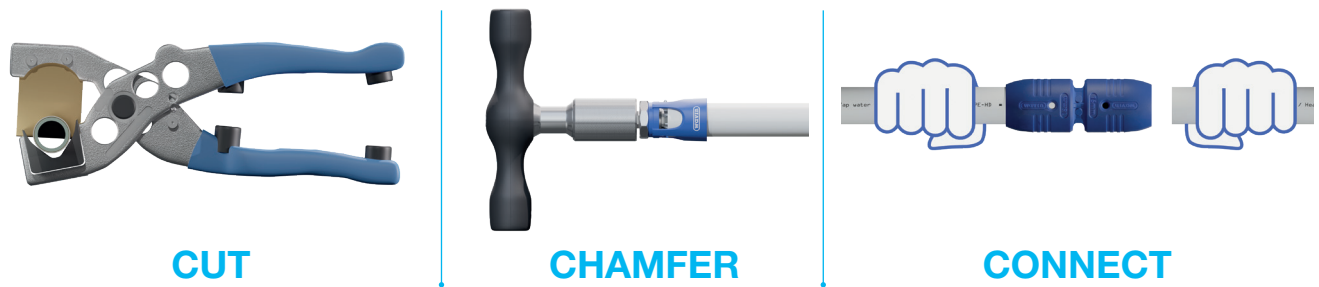

Fig.19: Tigris smartFIX with the reliable grab ring connection.

IN4SURE™

In order to make a reliable connection, it is important that the pipe is properly inserted into the fitting. The IN4SURE™ feature offers a visual check if the pipe is inserted far enough. The fittings have two observation windows, through which the insert depth of the pipe can be reliably checked.

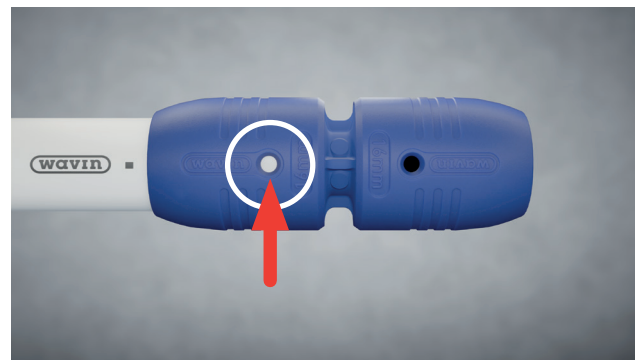

Fig.20: IN4SURE™ helps to check if the pipe is inserted properly.

2.4. Product matrix with features

The below overview gives a summary of the product features of the various Tigris designs, the body material, the dimensions and the pressing profile that can be used to create an utmost reliable installation. On the next page you will find an explanation of the icons that show the benefits of each feature.

Product feature overview						
		Tigris M5	Tigris K5	Tigris M1	Tigris K1	smartFIX
 MULTI JAW		✓	✓			
 OPTI FLOW		✓	✓			
 EASY FIT		✓	✓			
 ACOUSTIC LEAK ALERT	NEW	✓	✓			
 DEFINED LEAK		✓	✓	✓	✓	
 IN 4SURE		✓	✓	✓	✓	✓
 PIPE GRIP		✓	✓	✓	✓	✓
 ULTRA SEAL		✓	✓	✓	✓	✓
Diameters		14-40	16-40	50-75	50-75	16-25
Material		Brass	PPSU	Brass	PPSU	PPSU
Press profile		U, Up, TH, H, B	U, Up, TH, H, B	U	U	Push-Fit
Special dimensions		20 x 2.0 26 x 3.0	-	-	-	-

Table 1: Product feature overview.

2.5. Tigris feature explanation



MULTI JAW

Fits multiple pressing jaw profiles: U, Up, TH, B, H

Designed to fit the most common jaw profiles; U, Up, H, TH and B profiles. No need to buy new equipment, thus easy to switch to the new Tigris 5 series without worrying about your system warranty.



OPTI FLOW

Increased inner bore for optimized flow

An increased inner bore leads to an optimization of the flow, by reducing the pressure loss as a result of less flow resistance.



EASY FIT

Easy pipe insertion without calibration

After cutting the pipe (straight), it can be directly mounted on the pipe, without calibrating the pipe first. Thanks to the hexagonal sleeve, the special cap design and the recessed O-ring position, the pipe can be mounted with low forces and without risks of damaging the O-rings.



ACOUSTIC LEAK ALERT

NEW

Detect non-pressed fittings by a whistle

When the pipe is inserted in the fitting, but the installer forgot to press it, the connection will be leaking. . When executing a pressure test with air, the fitting can easily be acoustically traced by a whistling sound.



DEFINED LEAK

Clear visual water leaking when sleeve is not pressed

When the pipe is inserted in the fitting, but the installer forgot to press it, the connection will be leaking. When executing a pressure test with water, the fitting can easily be visually traced as it is leaking water.



IN4SURE™

Proper pipe position visible 360°

It is important to insert the pipe far enough to guaranty a tight sealing between pipe and fitting. A visual check proofs it is properly inserted.



PIPE GRIP

Pipe stays in position before pressing

When a pipe is properly inserted in the fitting, it should keep this position until the (fitting) cap is pressed. PipeGrip prevents undesired movements to ensure a reliable pressing.



ULTRA SEAL

Reliable O-ring sealing, tested beyond market standards

The reliability of the O -rings sealings is tested with a lifetime simulation test under extreme conditions. Tested to 110 ° C which is far above the required max temperature of 95 ° C.

Table 2: Product feature explanation.

2.6. Warranty

Please use the opportunity to gain a 10-year warranty on the Wavin Hot & Cold systems installed in your building project.

It is a condition for the issuing of the 10-year warranty that evidence is provided that the Wavin Products are installed according to the Wavin installation guidelines, the applicable legislation and regulations and all demands of the latest technical knowledge and the requirements of good and sound craftsmanship. Furthermore, your project must be registered at Wavin through the official 10-year warranty form.

Additional conditions are mentioned below:

1. Your project must be registered, and you must have installed a Wavin system for which Wavin can provide the 10-year warranty
2. The installation must have been completed within the last 3 months and the installed Wavin products have been installed within 12 months after delivery
3. The completed, signed and stamped "Registration for 10-year warranty form" must be promptly mailed to:

-
3. In a few days you will receive the original 10-year warranty by mail.

Please bear in mind that it is not possible to receive this warranty for individual Wavin products. For Hot & Cold applications both the pipes and the fittings comprising the complete installation have to originate from Wavin. For Underfloor Heating applications the pipes, manifolds and insulation panels have to originate from Wavin if applicable. In case the Wavin products are installed in combination with products from other suppliers which are also available at Wavin, the warranty cannot be supplied or if already supplied it loses its validity.



Registration for 10-year warranty form

Building project*

Name, property _____

Street _____

Postcode, town/city _____

Installer*

Company _____

Street _____

Postcode, town/city _____

Planner

Company _____ Postcode, town/city _____

Architect

Company _____ Postcode, town/city _____

Distributor

Company _____ Postcode, town/city _____

Type of property*

Residential unit

School

Home for the elderly

Multi-residential unit

Nursery school

Factory building

Residential complex

Bank

Church

Office/administrative building

Sports hall

Food outlet

Public building

Hospital

Museum

Store/shop

Doctor's practice

Swimming pool

Other

System(s)*

Quantity _____

Please specify the system for which the declaration of liability should be issued.

Required supporting documents (minimum of 1)*

- Copy of invoice _____
- _____
- _____

Installation and commissioning*

- System ready for use on _____
- Pressure test completed* on _____ No faults present
- Heating function checked on _____ No faults present

The system has been installed, checked and commissioned in accordance with the Wavin planning specifications, installation instructions and operating instructions.

Signature and stamp of the specialist company

Signature of building owner

By signing this document the installer accepts the applicability of the General Terms of Sale and Delivery of Wavin as published at www.wavin.nl.

**Mandatory fields*

3. Installation

Instructions

This chapter will provide you a clear instruction how to store, handle and install the various Tigris products in a professional, reliable and efficient way.

After a quick guide to get started and informing you about some general guidelines, it will guide you in detail from the preparation to execution and to final testing of the finished installation.

Please read the instructions carefully, especially when working with Wavin Tigris products for the first time. This chapter will end by showing examples of the most common installation designs.

3.1. Overall installation instructions

The respective current codes of practice must be observed in the installation of Wavin Tigris K5, Tigris M5, Tigris K1, Tigris M1 and Tigris smartFIX systems. These systems are to be assembled only by trained and qualified professionals and with appropriate tools only.

Wavin Tigris systems are constructed in accordance with the relevant codes of practice. The mountings used must be adequate for fixing the composite pipe in the respective nominal diameter. Mountings with a sound and temperature insulation insert are recommended.

The expected linear expansion based on maximum temperature feed and line length must be considered. A distinction is generally drawn between fixed points and floating points as fixing methods. Fixed points divide the pipeline element into separate sections and provide stability. Floating point fixings enable expansion and movement of the pipeline concerned. Please see the detailed instructions in the chapters that follow that will help you making the perfect, right-first-time installation.

3.2. A quick guide to get started

The next page overview gives you a quick guide to get easily started with installing the Tigris family products. In the chapters that follow you will find out all details that help you making a perfect installation.

Before starting the installation, always check pipes and fittings for dirt and internal damage to prevent an eventual negative impact on the reliability of the system.

Tigris K5 | M5
16 - 40 mm

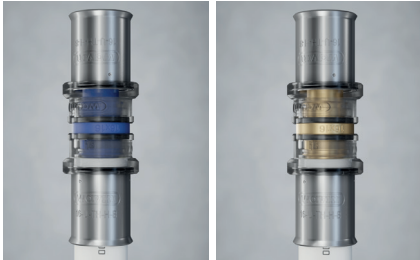

Tigris K1 | M1
50 - 75 mm



smartFIX
16 - 25 mm

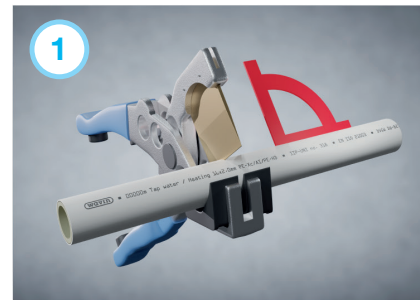

Fig. 21: A quick installation guide to get started.

3.3. Detailed installation instructions

3.3.1. Making a press-fit connection

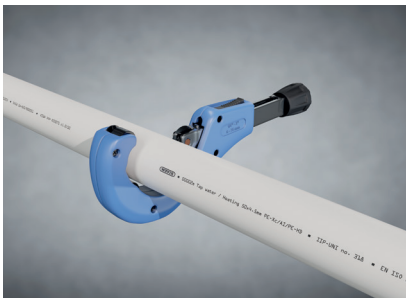

Fig. 22: Cutting the pipe.



Fig. 23: Calibrating the pipe.

1. Preparation

Always use the right pipe cutter to ensure a proper cut. By using other tools, like e.g. saws the system guarantee is affected.

Combination cutters (with pipe holder) for the dimension 16 – 25 mm ⁴⁾, Pipe cutter for the dimension 32 – 75 mm. Make sure the cut is always made perpendicular to the pipe. Remove eventual remaining burrs or sharp edges.

⁴⁾ For Italy including 26 mm, 14 mm for the Netherlands.

2. Calibration and chamfering

For Tigris K1/M1 and smartFIX calibration and chamfering is always required. For Tigris M5/K5 it is just recommended, especially for 32 and 40 calibration is recommended to reduce push in forces. Only use the original Wavin calibration tools. By using other calibration tools the system guarantee is affected.

- ④ Dimensions ⁵⁾ 16 – 25 mm: all-round chamfer of depth minimal 1 mm. Maximum battery or drilling machine rotation speed should be 500 rpm. Remove accumulated shavings from the calibrating pin.
- ④ Dimensions 32 – 75 mm: all-round chamfer of depth minimal 2 mm. Do not use a battery or drilling machine for safety reasons.
- ④ smartFIX: If one end of the pipe is already connected to the fitting, the opposite end should not be calibrated without resistance, to avoid the pipe rotating in the fitting

⁵⁾ For Italy including 26 mm, 14 mm for the Netherlands.

3. Push in and check

Make sure the pipe is correctly inserted and is visible in the check window (IN4SURE™).

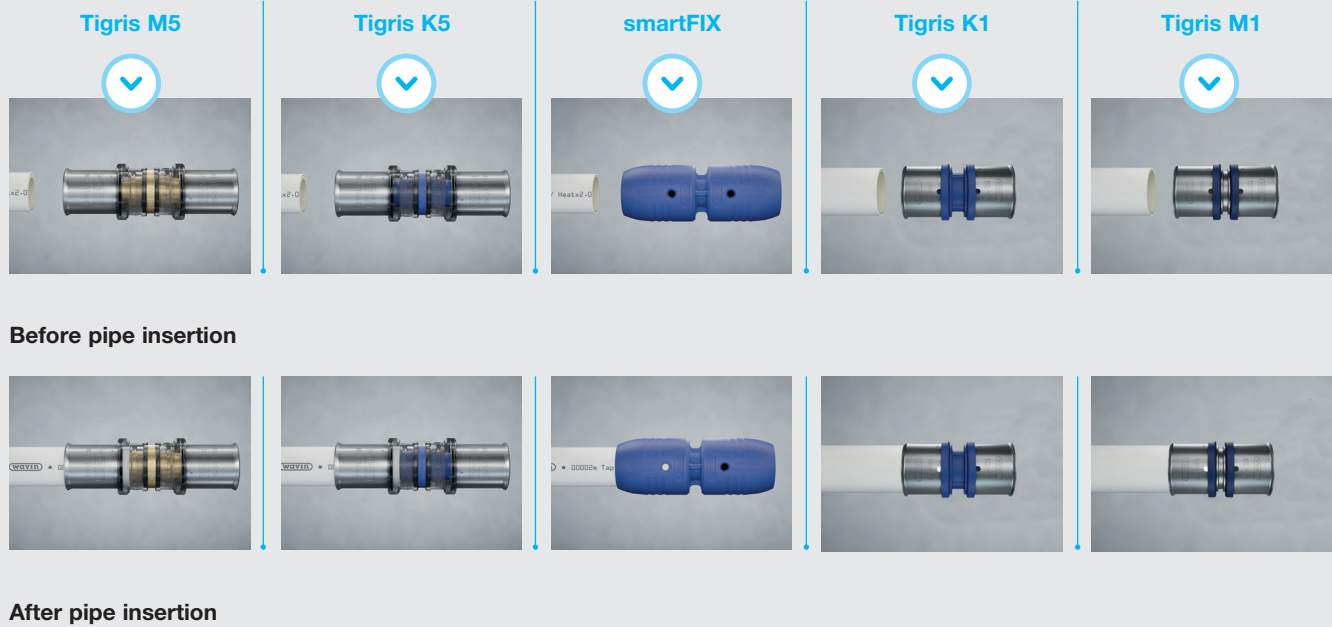

- ⦿ Tigris K5 and Tigris M5: Push the pipe into the fitting until the stop (visible in fix ring window)
- ⦿ Tigris K1 and Tigris M1: Push the pipe into the fitting until the stop (visible in cap window)
- ⦿ smartFIX: Push the pipe into the fitting to the stop (visible in cap window)

Fig. 24: Checking the correct pipe insertion with IN4SURE™.

4. Execute pressing

Press Systems Tigris K5/M5 and Tigris K1/M1: Always position the jaw perpendicularly between the guides of the cap and fixing. For Tigris K1/M1 only use U/Up press profiles. For Tigris K5/M5 you can use U/Up/B/TH/T profiles, see details about the various cap positions in the sketches below.

The pressing itself shall only be executed once per sleeve.

Multiple pressing Jaws

In general all Tigris Radial Press-Fit fittings (up to 75 mm) can be pressed with pressing jaws with the “ U” (and “Up”) profile. The Tigris K5 and Tigris M5 (16-40 mm) can, next to “U” and “Up”, additionally be pressed with” TH” , “H” and “B” profile. Below gives the right positioning of the jaws on the fitting.

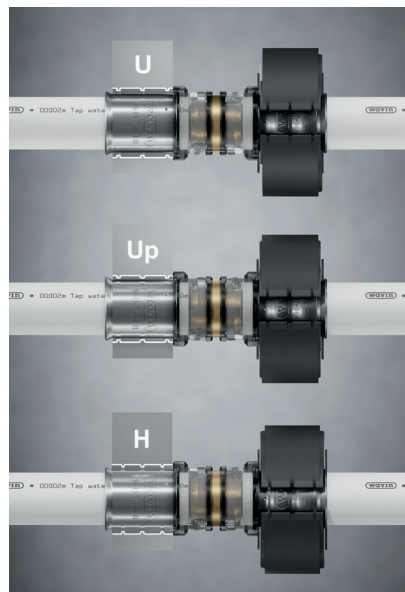

U-Up-H profiles

Pressing jaws should just cover the metal cap, in between the collar of the cap and the transparent fix ring collar. Use the fixing as a guidance.

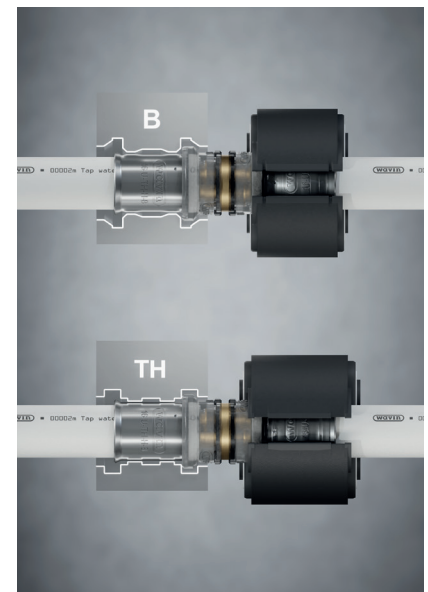

TH- B profiles

Pressing jaws should cover the metal cap, including the cap collar and fix ring collar. The big grooves in the pressing jaws should be positioned over the cap collar and over the fix ring collar.

Fig. 25: Positioning the pressing jaws on the fitting with Tigris K5 and Tigris M5.

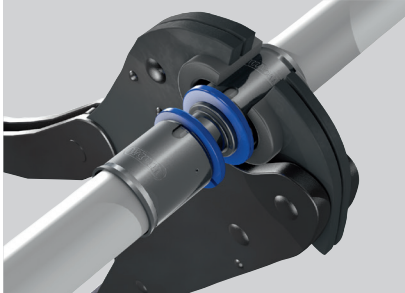

Fig. 26: Positioning the pressing jaws on the fitting with Tigris K1 and Tigris M1.

Tigris K1 and Tigris M1 :

The pressing jaws must be positioned on the inner collar side of the press sleeve. Always finish your installation with a visual system check and the required pressure tests, following the local procedures.

See chapter 4.3. Cordless and electric press tools for the appropriate pressing tools.

3.3.2. Pipe bending

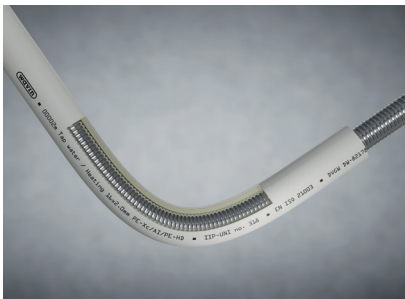

Fig. 27: Bending the pipe with a bending spring.

By bending the pipe the demand of fittings needed for the installation can be reduced. The pipe is easy to bend: by hand, with the aid of the bending spring or using the Wavin bending pliers. Bending springs and bending pliers are preferred to be used to ensure the pipe is not kinked by accident. Larger diameters can be bend with pliers with appropriate dimensions, bending radius min. 3x \varnothing a.

Measurement Da x s mm	Bending radius By hand mm	Bending radius Bending spring mm	Bending radius Bending iron mm
16 x 2,0	5 x $\varnothing \approx 80$	4 x $\varnothing \approx 64$	ca. 46
20 x 2,2	5 x $\varnothing \approx 100$	4 x $\varnothing \approx 80$	ca. 52
20 x 2,25	5 x $\varnothing \approx 100$	4 x $\varnothing \approx 80$	ca. 52
25 x 2,5	5 x $\varnothing \approx 125$	4 x $\varnothing \approx 100$	ca. 83
26 x 3,0	5 x $\varnothing \approx 130$	4 x $\varnothing \approx 105$	ca. 88
32 x 3,0	-	-	
40 x 4,0	-	-	
50 x 4,5	-	-	
63 x 6,0	-	-	
75 x 7,5	-	-	

Table 3: Bending radius overview.

3.3.3. Tigris M5 Metal Connector: Assembly instructions

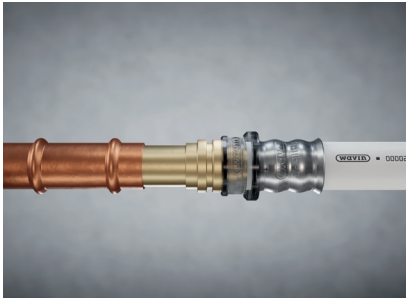

Fig. 28: Transfer coupler to metal and copper pipes with Tigris K5 and Tigris M5.

- ④ Check the copper/metal pipe on damages or burs. Remove damaged section or burs before continuing.
- ④ Slide the press connection into the copper fitting and press according to the specifications of the copper fitting manufacturer. A minimum space of 5 mm must be observed between the soldered joint and outer edge of the copper fitting.
- ④ Press the copper fitting on the pipe according to the instructions of the copper fitting supplier.
- ④ Mount the Tigris pipe according to the Tigris M5 and Tigris K5 assembly steps described in the chapter A quick guide to get started

Attention: Do not solder, otherwise the sealing rings on the press transition to copper might be damaged.

3.3.4. smartFIX push-fit transition to copper

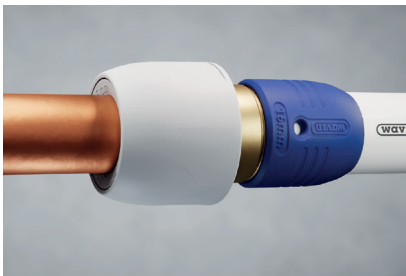

Fig. 29: Transfer coupler to metal and copper pipes with smartFIX.

- ④ Cut the copper pipe to length at right angles
- ④ Carefully deburr the copper pipe inside and outside Soft copper pipe must be calibrated
- ④ Check the transition coupling for cleanness and correct position of the sealing elements. Push the transition coupling onto the copper pipe as far as it will go. Do not use oil or any lubrication.
- ④ Mount the Tigris pipe following the Tigris smartFIX assembly instructions (see chapter 3: A quick guide to get started) Check the proper insertion of the Tigris pipe in the window of the blue cap.

3.3.5. Repair Couplers

In case a damaged or leaking section of pipe is found in a finished installation, the affected pipe section can be replaced by using the Wavin Repair Coupler. Follow the below steps for a reliable installation.



1. Reveal the area around the leaking part when the pipe is covered by eg plaster or concrete.

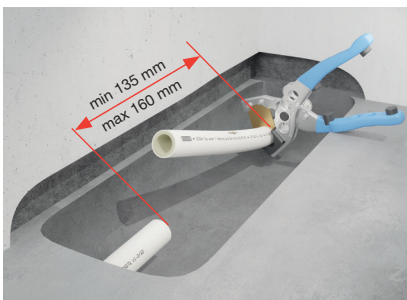

2. Cut away the pipe section that is damaged or leaking.

Note the minimum and maximum distance between both pipe ends, in order to guarantee a secure new connection.

- ⌚ Minimum length 135 mm
- ⌚ Maximum length 160 mm

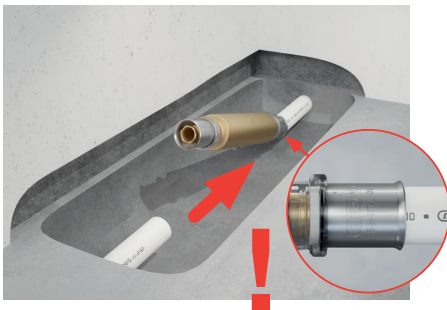

3. Make sure the pipe surface is completely smooth and clean.
Place one connector of the Repair Coupler on one of the free pipe ends.
Check in the viewing window that the pipe is inserted correctly. (IN4SURE™)



4. Press the assembled connection.



5. Pull out the free end of the Repair Coupler and insert the other connector onto the remaining free pipe end.

Check in the viewing window that the pipe is inserted correctly. (IN4SURE™)



6. Press this second assembled connection.

Fig. 30: Installation steps repair coupler.

7. Finally execute the regular pressure test, to make sure the installation is leak tight again.

3.3.6. Threaded fittings

To ensure a reliable connection to other pipe systems and other components of the installation standardized threaded connectors can be used.

A threaded connection should be made as follows:

- ⦿ Cover the male thread with PTFE sealing tape or another suitable sealing tape.
- ⦿ Tighten both screw fittings by hand.
- ⦿ After tightening the connection by hand, use an open-end wrench to tighten it a maximum of two turns.
Avoid at all times that the thread connection is turned to the end of the thread to avoid eventual leaking.
- ⦿ Do not reverse the fitting.
- ⦿ If the male thread is fully inserted into the female thread all the way to the end, it should be removed again and more PTFE sealing tape shall be used.

The assembly of a threaded connection must be in accordance with the local standards, like **DIN 30660** and **DIN EN 751-2**. We strongly recommend the use of **PTFE / Teflon Tape** to seal the connection. Alternatively, hemp may be used but only in conjunction with an approved plastic sealing compound such as **Fermit**. Restrict the amount of hemp as too great a quantity can result in damage to the internal threads and cross-threading. When using hemp make sure that the thread tips remain visible. **Check the local regulations about using hemp in drinking water installations.**

3.4. General guidelines for handling and storage



Storage and handling

The Wavin system components are well protected in the original packaging. Nonetheless, all components (fittings and pipes) should be protected from mechanical and environmental damage.



Impairment due to ultraviolet radiation

Wavin multi-layer composite pipes must be protected from direct, intense sunlight and ultraviolet (UV) radiation. This applies both for the storage of the pipes and for finished installation. Storage must therefore not take place in the open air. Suitable measures must be taken to protect finished systems and system components from the effects of UV rays.



Observe press and push-fit fitting assembly instructions

- ④ Always cut the pipe to length at right angles
- ④ Tigris K1, Tigris M1, smartFIX: Calibrate and chamfer the pipe end all round
- ④ Push the pipe into the fitting to the stop
- ④ Check the press or push-fit fitting observation window respectively the transparent fixing
- ④ Press in the case of the press fittings
- ④ See chapter 3 Detailed installation instructions for further details.



Potential equalisation

Building and electrical regulations, such as DIN VDE 0100-540 VDE 0100-540, demand potential equalisation between earth wires and “conductive“ water, wastewater and heating pipes. As Wavin hot and cold water systems do not represent conductive pipe systems, they cannot be used for potential equalisation and are accordingly not to be earthed. An approved electrician must check that the installation of Wavin Tigris K1/M1, Tigris K5/M5 and Wavin smartFIX does not impair the existing electrical protective and earthing measures.

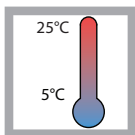

Installation temperature

The installation temperature for Wavin pipe systems should not fall below -10°C. The operating temperatures of the new pressing machines with the Li-ion batteries from the Wavin range must be above -15°C not above 40°C. The optimum processing range for Wavin Tigris K1/M1 and Wavin smartFIX system components lies roughly between 5°C and 25°C.



Frost protection

When using Wavin Tigris with pipe networks that require protection from frost (e.g. cold water networks, brine pipes), we recommend the use of ethylene glycol (to protect from risk of freezing). Ethylene glycol can be used up to a maximum concentration of 35%. This concentration roughly corresponds to frost proofing of -22°C. Before using alternative frost protection additives, confirm the suitability/approval with the manufacturer or with Wavin.



Sealing

The assembly of a threaded connection must be in accordance with the local standards, like DIN 30660 and DIN EN 751-2. We strongly recommend the use of PTFE / Teflon Tape to seal the connection. Alternatively, hemp may be used but only in conjunction with an approved plastic sealing compound such as Fermit. Restrict the amount of hemp as too great a quantity can result in damage to the internal threads and cross-threading. When using hemp make sure that the thread tips remain visible. Check the local regulations about using hemp in drinking water installations.



Contact with substances containing solvents

Avoid direct contact of Wavin Hot and Cold Water Systems with solvents or construction materials containing solvents (such as paints, sprays, expanding foams, adhesives [as e.g. Armaflex 520]). Aggressive solvent can lead to negative impact on the plastic material. Because ammonium- chloride and nitrate containing media can cause crack corrosion, the used material and auxiliary materials as well as the surrounding environment must be free of this to avoid impact on the metal material.

Note

Specifically, chemical sealants (e.g. Loctite55) and adhesives (e.g. 2-part adhesives) must not be used. Expanding foams produced on the basis of methacrylate, isocyanate and acrylate must not be used. Under unfavourable circumstances, aggressive chemicals that are present may cause damage to the plastic material. The Wavin systems do not require the use of any chemical substance or additional lubrication during installation. Cold welding agents as used for welding PVC protection foils for pipe insulations, which contain Acetone or Tetrahydrofuran (THF), must not be used.

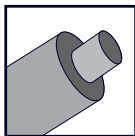

Insulation

Pipes and connectors always have to be insulated according the local laws or regulations.



Water heaters and flow-type heaters

The white Wavin multi-layer composite pipes are suitable for applications according ISO 10580 for drinking water applications according class 2 and heating applications according class 5 (see table in chapter Thermal Disinfection). Thermal overloading of the composite pipe network must be avoided by taking appropriate safety precautions, including the use of suitably regulated equipment and monitoring equipment. The equipment has to be approved as suitable for this application by the manufacturer.

3.5. Finalizing the installation; leak and pressure tests and flushing

3.5.1. Pressure tests (Defined Leak & Leak Alert)

After finalizing the installation, a leak- and pressure check should be executed. The tests can be executed with water or (clean) pressurized air. Be aware that depending on the circumstances, testing with water might require additional measures to prevent legionella caused by stagnated water afterwards.

Working with pressure always requires taking the necessary precautionary measures!

One of the causes of leakage can be an unpressed connection or wrongly pressed connection.

Wavin Tigris offers 2 time saving ways of easily tracing the untighten connections when executing a pressure test to safe time in the final pressure test that is required for installation release; Defined Leak or Acoustic Leak Alert.

3.5.2. Function check with water- Defined Leak

The Defined Leak test serves as an initial check to instantly trace unpressed connections when executing the installation function check. When the function check is carried out with water, the leak from unpressed connections is clearly visually identifiable by dripping water from the fitting. Press the fitting or replace a wrongly pressed fitting to restore the connection. Repeat the check until all malfunctioning fittings have been properly pressed.

It is advised to always start with carrying out a visual check on the connections (pressed/unpressed) to avoid any damage caused by leaking water.



Fig. 31: Defined leak when testing with water.

After this initial check, the system can be pressurized according to the local required procedures to execute the pressure test. Below you find a summary of a common test procedure for testing with water. Please check your local regulations for local defined procedures in executing the pressure check with water.

Pressure test with water

It is essential that a system pressure test is carried out in line with the relevant local regulations for plastic pipe systems used for drinking water or heating systems. Clean filtered drinking water should be used for the test.

If there are no clear local regulations available then Wavin recommends to use the testing procedures according to DIN 1998 Part 2. The main requirements of the test conditions, including records to be kept are summarised below.

Due to the risk of high pressures, it is common and recommended to execute the water pressure test in 2 steps. A practical and save method is described in the German (BTGA 3002) as well as the Dutch (WB 2.3) testing procedures. These procedures distinguish the following 2 steps:

- 1) check connections on leak tightness
- 2) check connections on pressure resistance

For step 1 the system is stepwise pressurized up to approx. 2,5 bar (WB 2.3) and set for a defined time frame (minimum 10 min for WB 2.3). The pressure on the system is noted at the start and the end of this period. Differences between the initial installation pressure and the pressure after the defined time indicate if the pressure test has been executed successfully (no pressure drop) or if there are leaks (pressure drop).

Wavin Defined Leak has been designed to instantly indicate leaking fittings at this stage of the process. This means that malfunctioning connections can instantly and safe be discovered in a visual way by looking for the dripping fitting. This saves valuable time in diagnosing and tracing a malfunction.

For step 2 the system is pressurized on 1,1 times the maximum working pressure (normally 10 bar) , this means a test pressure of 11 bar. Again the pressure on the system is noted at the begin and the end of the defined time frame (minimum 10 min for WB 2.3).

Differences between initial pressure and final pressure after the defined time indicate if the pressure test has been executed successfully.

Be aware that SAFETY PRECAUTION MEASURES are taken when applying high pressures on the piping system.

The results should be recorded and signed for.

Below is an indicative schedule of the leak test procedure as described above.

3.5.3. Function check with air- Acoustic Leak Alert

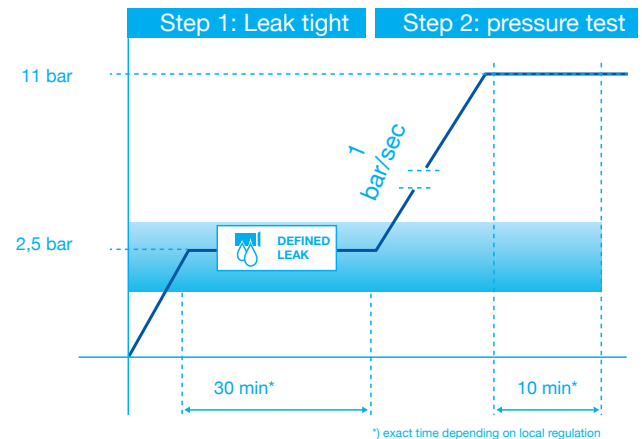

Fig. 32: Pressure test protocol when testing with water.

The Acoustic Leak Alert test serves as an alternative check to instantly trace unpressed connections when executing the installation function check.

With Tigris K5 and Tigris M5 there is now an alternative way to check for unpressed connections with air pressure instead of water.

Testing with air instead of water can be beneficial for several reasons. There is no danger of frosted pipes or water damage, there is no potential legionella risk caused by stagnating water and it is a clean way of testing, that can be executed independently from available water supplies on building sites.

When the function check is carried out with air, the leak from unpressed connections is easily traceable by a loud acoustic whistle sound (around 80 dBA) generated by the leaking connection.

By just following the sound, the connection can be found and pressed or replaced, depending the cause of the leak. Repeat the check until all malfunctioning connections have been properly pressed.

After this initial check, the system can be pressurized according to the local required procedures to execute the pressure test. Below you find in a summarized way a common test

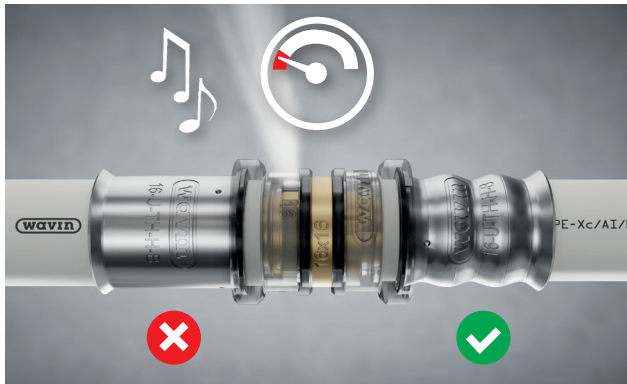

Fig. 33: Acoustic Leak Alert when testing with air.

procedure for testing with air. Please check your local regulations for local defined procedures for executing the pressure check with air.

Pressure test with air

Due to the risk of high pressures, it is common and recommended to execute the air pressure test in 2 steps. A practical and save method is described in the German (BTGA 3002) as well as the Dutch (WB 2.3) testing procedures. These procedures distinguish the following 2 steps:

- 1) check connections on leak tightness
- 2) check connections on pressure resistance

For step 1 the system is pressurized at approx. 0,15 bar for a defined time frame (minimal 30 min for BTGA 3002). The pressure on the system is noted at the start and the end of the period. Differences between the initial installation pressure and the pressure after the defined time indicate if the pressure test has been executed successfully.

Wavin Acoustic Leak Alert has been designed to easily indicate leaking fittings at this stage of the process. If a pressure drop is found, leaking fittings can instantly and safely be discovered by an acoustic signal. By pressurizing the system starting from 0,15 bar up to 0,3 bar, with a maximum of 0,5 bar (for safety), the leaking fitting will generate a clear and loud whistle. This saves valuable time in diagnosing and tracing a malfunction*.

*) Be aware that Acoustic Leak Alert is just an aid to rapidly find the leaking fitting. It does NOT replace the required leak- and pressure test.

This feature is available for Tigris M5 and Tigris K5 only. In case of a mixture of Tigris M1, M5, K1 and K5 fittings, it is advised to execute the pressure test with water.

For step 2 the system is pressurized, depending of the pipe OD, with 3.0 bar (\leq DN/OD 63 mm) or 1,0 bar ($63\text{mm} > \text{DN/OD} < 110 \text{ mm}$). Again, the pressure on the system is noted at the begin and the end of the defined time frame (minimal 30 min for BTGA 3002).

Differences between initial pressure and final pressure after the defined time indicate if the pressure test has been executed successfully.

Be aware that SAFETY PRECAUTION MEASURES are taken when applying high pressures on the system.

The results should be recorded and signed for.

Below is an indicative schedule of the leak test procedure as described above.

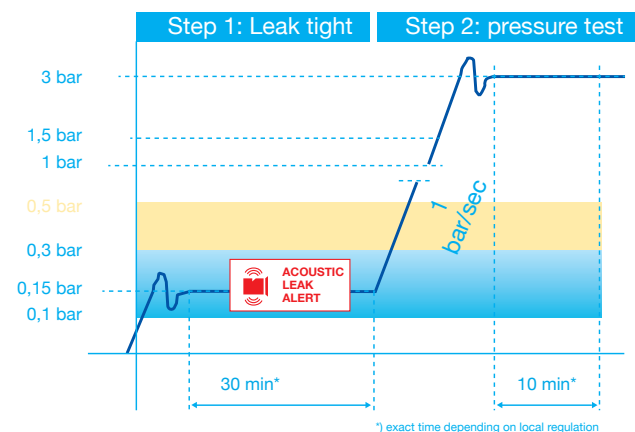

Fig. 34: Pressure test protocol when testing with air.

3.5.4. Flushing

The flushing of tap water pipes is described in detail in DIN 1988-2/EN 806-4. This treatment of the pipe network ensures the quality of the tap water. All pipe sections must be free of contamination and foreign bodies at the time of initial operation. Time delays between flushing and initial operation of the tap water network must be avoided. Please check your country local procedures for the intervals for flushing in case of stagnating water (eg VDI 6023)

3.5.5. Initial operation and handover

According to DIN 1988-2/EN 806-4, the installer of the system must prepare relevant handover and acceptance logs. The system operator must be instructed with respect to the operation of the tap water system created. It is recommended that the instruction being completed is confirmed in writing.

Depending on the scale of the system, the presentation of written operating instructions is advised.

3.5.6. Usage of the Wavin Tigris pressure test plug

The Wavin Tigris pressure test plug is screwed on the pipe that shall be tested. The pipe must completely fill the check window. After the execution of the pressure test, the pressure test plug has to be unscrewed again. The area where the pressure test plug was screwed on the pipe (thread cuts are visible) must be cut off before further processing.

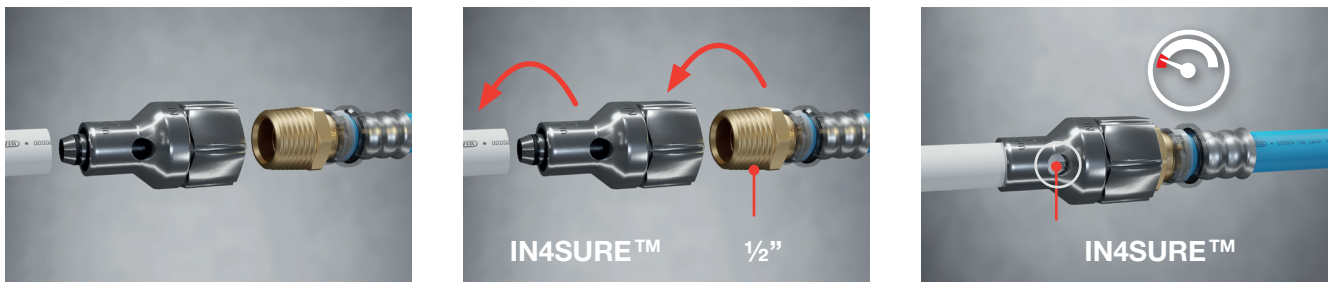

Fig. 35: Pressure check with coupler: 16 mm: 4013571 - 20 mm: 4013572 - 25 mm: 4013573.

3.5.7. Protocol pressure test for drinking water installations (if no local test regulation available)

Example protocol Pressure test drinking water installations - testing with Water

(Based on test protocol from BTGA Regel 5.001; pressure test with water)

Building project: _____

Clients represented by: _____

Contractor represented by: _____

Pipe system material: _____

Connection type: _____

System operating pressure : _____ bar

Ambient temperature: _____ °C test medium _____ °C Δt _____ K

The drinking water system has been tested as total installation in _____ sections

Designation of the subsection: _____

Subsection Nr _____ from total of _____ subsections.

The filling water is filtered, and the line system is fully vented

All lines were sealed with metal plugs, caps, blanking plates or blind flanges.

Appliances, pressure tanks or drinking water heater were disconnected from the lines.

A visual inspection of all pipe connections to proper execution has taken place

Metal, multi-layer composite and PVC pipes

Plastic pipes made of PE, PP, PE-X, PB and therewith combined pipes from multi-layer and metal

- 1) If $\Delta t > 10$ K, 30 minutes wait time after application of the system pressure, before actual testing. If $\Delta t < 10$ K go to step 2
- 2) Apply the actual test pressure of min. 1.1 times (11 bar) of the maximum allowable working pressure (10 bar according to DIN EN 806-2). Test time: 30 min.
- 3) Reduce the pressure to 0.5 times (5.5 bar) of the initial test pressure and implement a visual inspection. Test Time: 30 Min.
- 4) Evaluation: During the test period no pressure drop occurred ($\Delta p = 0$). Leaks are not present.

The pipe system is: **tight**

leaking

Client signature/ stamp _____

Place, date _____

Contractor signature/ stamp _____

Example protocol Pressure test drinking water installations - testing with Air

(Based on test protocol from BTGA Regel 5.001; pressure test with air or inert gasses)

Building project: _____

Clients represented by: _____

Contractor represented by: _____

Pipe system material: _____

Connection type: _____

System operating pressure : _____ bar

Ambient temperature: _____ °C test medium _____ °C Δt _____ K

The drinking water system has been tested as total installation in _____ sections

Designation of the subsection: _____

Subsection Nr _____ from total of _____ subsections.

The filling water is filtered, and the line system is fully vented

All lines were sealed with metal plugs, caps, blanking plates or blind flanges.

Appliances, pressure tanks or drinking water heater were disconnected from the lines.

A visual inspection of all pipe connections to proper execution has taken place

Metal, multi-layer composite and PVC pipes

Plastic pipes made of PE, PP, PE-X, PB and therewith combined pipes from multi-layer and metal

5) If $\Delta t > 10$ K, 30 minutes wait time after application of the system pressure, before actual testing. If $\Delta t < 10$ K go to step 2

6) Apply the actual test pressure of min. 1.3 times of the maximum allowable working pressure

7) Test Time: 120 Min.

8) Evaluation: During the test period no pressure drop occurred ($\Delta p = 0$). Leaks are not present.

The pipe system is: **tight**

leaking

Client signature/ stamp _____

Place, date _____

Contractor signature/ stamp _____

3.5.8. Pressure test for radiator installations in accordance with DIN 18380 (if no local test regulation available)

Example protocol Pressure test heating installations - testing with Water

(Based on test protocol from BTGA Regel 3.002; pressure test with water)

Building project: _____

Clients represented by: _____

Contractor represented by: _____

Pipe system material: _____

Connection type: _____

System operating pressure : _____ bar ambient temperature _____ °C test medium _____ °C
Test medium oil-free compressed air Nitrogen CO₂ Other _____

The drinking water system has been tested as total installation in _____ sections

Designation of the subsection: _____

Subsection Nr _____ from total of _____ subsections.

**All lines were sealed with metal plugs, caps, blanking plates or blind flanges.
Appliances, pressure tanks or drinking water heater were disconnected from the lines.
A visual inspection of all pipe connections to proper execution has taken place**

Leak testing

Test pressure 150 mbar
Test time to 100 Liter of tap volume at least 30 minutes.
Test time to be increased by 10 minutes for each additional 100 liters of tap volume.

Tap volume _____ Liter Test time _____ min

Temperature compensation and steady-state in case of **plastic materials** is awaited, after which the test period begins.

During the test period no pressure drop was detected

Load test with increased pressure

Test pressure ≤ DN 50 max. 3 bar > DN 50 max. 1 bar
Test time 10 min. (Deviating test time: _____ min)

Temperature compensation and steady-state in case of plastic materials is awaited, after which the test period begins

During the test period no pressure drop was detected

The pipe system is: **tight** **leaking**

Client signature/ stamp _____

Place, date _____

Contractor signature/ stamp _____

Example protocol Pressure test heating installations- testing with Air

(Based on test protocol from BTGA Regel 3.002; pressure test with air or inert gasses)

Building project: _____

Clients represented by: _____

Contractor represented by: _____

Pipe system material: _____

Connection type: _____

System operating pressure : _____ bar ambient temperature _____ °C test medium _____ °C
Test medium oil-free compressed air Nitrogen CO₂ Other _____

The drinking water system has been tested as total installation in _____ sections

Designation of the subsection: _____

Subsection Nr _____ from total of _____ subsections.

**All lines were sealed with metal plugs, caps, blanking plates or blind flanges.
Appliances, pressure tanks or drinking water heater were disconnected from the lines.
A visual inspection of all pipe connections to proper execution has taken place**

Note:

The Contractor shall subject the system after installation and before closing the wall slots, wall and ceiling openings and, where appropriate before applying the screed or other coverage of a pressure test. When pressure testing, manufacturer's instructions of the tested components must be observed.

Leak testing

Test pressure 150 mbar

Test time to 100 Liter of tap volume at least 30 minutes.

Test time to be increased by 10 minutes for each additional 100 liters of tap volume.

Tap volume _____ Liter

Test time _____ min

Temperature compensation and steady-state in case of **plastic materials** is awaited, after which the test period begins.

During the test period no pressure drop was detected

Load test with increased pressure

Test pressure ≤ DN 50 max. 3 bar > DN 50 max. 1 bar

Test time 10 min. (Deviating test time: _____ min)

Temperature compensation and steady-state in case of plastic materials is awaited, after which the test period begins

During the test period no pressure drop was detected

The pipe system is: **tight** **leaking**

Client signature/ stamp _____

Place, date _____

Contractor signature/ stamp _____

3.6. Linear expansion and fixing

The respective current codes of practice must be observed in the installation of Wavin Tigris K5, Tigris M5, Tigris K1, Tigris M1 and smartFiX hot and cold water systems. These systems are to be assembled by trained and qualified professionals and with the appropriate tools only.

3.6.1. Basics

Wavin Tigris K5, Tigris M5, Tigris K1, Tigris M1 and smartFiX Hot and Cold Water Systems are constructed in accordance with the relevant codes of practice.

The mountings used must be adequate for fixing the composite pipe in the respective nominal diameter. Fixing systems with a sound insulation insert are recommended. The expected linear expansion based on maximum temperature feed and line length must be taken into account.

A distinction is generally drawn between fixed points and floating points as fixing methods. Fixed points divide the pipeline element into separate sections. In the case of straight pipe routes, a fixed point is to be applied at the mid-point. No fixed points should be applied directly at fittings that are used for a change of direction. Sufficient stability of the fixed points is required in order to effectively absorb the expansion forces occurring. A short distance to the ceiling must be observed. Vertical lines, such as risers, can generally be installed only with fixed point clips. Here, fixing should be in front of or behind each storey branch. By contrast, floating point fixings guarantee expansion and movement of the pipeline concerned.

For more information about this, please refer to the next chapter.

Use metal clamps with a rubber inlayer to prevent construction born sound. This allows also a little bit of movement without large tension. Do not attach Tigris pipe systems to other piping systems, e.g. soil & waste systems.

3.6.2. Consideration of thermally induced linear expansion

All pipe materials expand on heating and contract on cooling. In the case of the piping for tap water systems (particularly with heated tap water) and heating pipes, the temperature-based linear expansion of the materials must always be considered.

The temperature difference and pipe length constructed determine the length change. For assembly, the movement possibilities for each direction change must be considered.

Irrespective of the pipe size, the coefficient of expansion of Wavin multi-layer composite pipes is 0.025 – 0.030 mm/m·K. The length changes of Wavin multi-layer composite pipes as expected in operation with different pipe lengths and temperature differences can be determined from the following diagram.

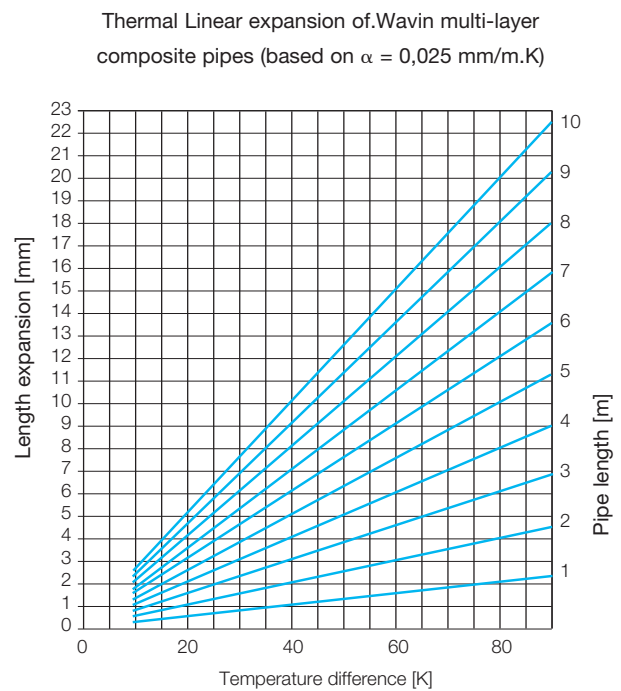

Fig. 36: Thermal Linear expansion.

The length changes can likewise be calculated using the following formula

	$\Delta l = \alpha \times l \times \Delta \vartheta$ Δl = Length expansion (mm) α = Coefficient of length expansion (mm/m.K) l = Pipeline length (m) $\Delta \vartheta$ = Temperature difference (K)
Sample calculation: Given:	Wavin Tigris K1 hot water pipe Pipe length (l) 12 m Lowest ambient temperature 10 °C Mediumtemperature 60 °C
Sought:	Maximum length expansion under operating conditions $\Delta l = \alpha \times l \times \Delta \vartheta$ $60 \text{ K} - 10 \text{ K} = 50 \text{ K}$ $0,025 \text{ mm/m.K} \times 12 \text{ m} \times 50 \text{ K} = 15 \text{ mm}$
Result:	Maximum length expansion under operating conditions = 15 mm

Fig. 37: Calculation example length change.

3.6.3. Absorption of length changes by bending joints

In the case of a change of direction, the thermal length expansion of a pipeline can often be offset within the pipe layout by bending joints and expansion U-bends. The length of the bending joint can be determined by calculation or taken from the diagram below.

Key:

- LB = Length of the bending joint [mm]
- d = External pipe diameter [mm]
- ΔL = Length change [mm]
- C = Material-dependent constant for Wavin multi-layer composite pipe (= 30)
- LB = C · d · ΔL

Bending joint classification Wavin multi-layer composite pipe

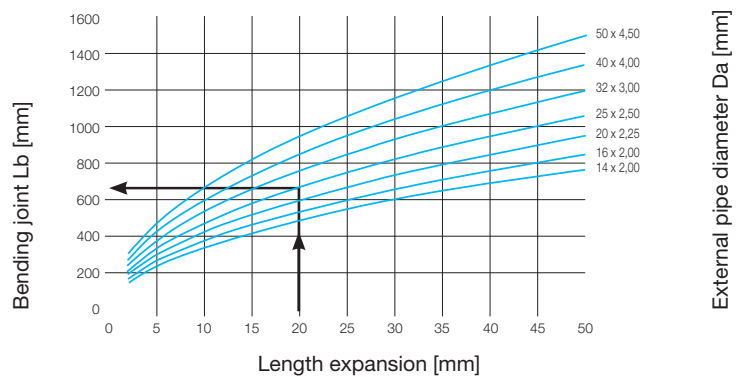
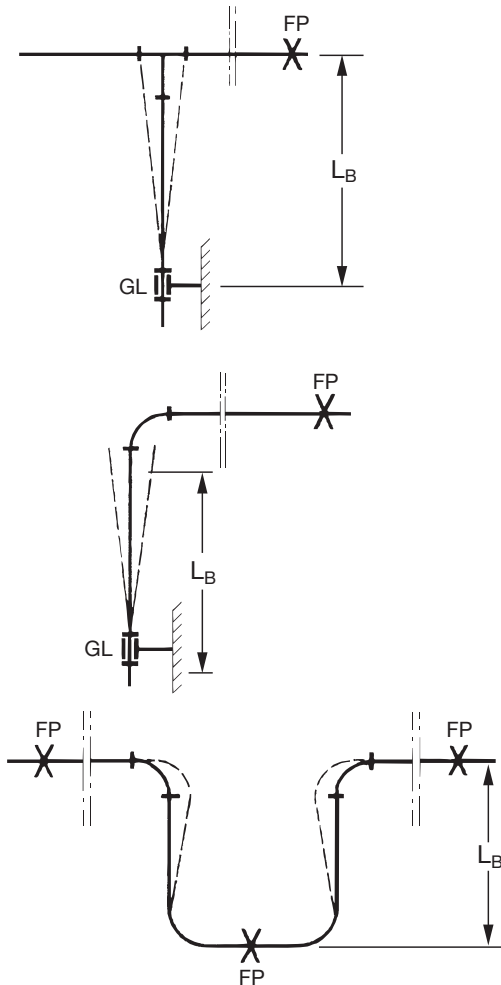

Fig.38: Bending joint classification of Wavin multi-layer composite pipes.

Given:	Length change $\Delta l = 20$ mm Pipe diameter $d = 25 \times 2,5$ mm Constant c for Tigris K1/M1/smartFIX = 30
Sought:	Length of the bending joints L_B
Result:	650 mm, from diagram above

Fig. 39: Calculation example length bending joints.



FP = Fixed point
GL = Floating point

Fig. 40: Floating and fixed point mounting.

3.6.4. Fixing intervals

Pipelines on a supporting base must be fixed in accordance with DIN 18560-2: 4.1, EN 13813-01. The number of fixing components is essentially dependent on the piping in the respective construction project. As the calculation basis with straight piping, a fixing component can be attached at approx. 1 m pipe length. In the areas of diversion, at least two fixing components are to be affixed (before and after the diversion curve).

Dimension (mm)	Fixing interval (m)
16 x 2,0	1,00
20 x 2,25	1,20
25 x 2,5	1,50
32 x 3,0	1,50
40 x 4,0	1,80
50 x 4,5	1,80
63 x 6,0	2,00
75 x 7,5	2,20

Table 4: Pipe clamp intervals for Wavin multi-layer composite pipes installed in exposed locations.

The type and intervals of the fixings are dependent on pressure, temperature, medium and installation situation. The pipe fixings must be properly designed according to the total mass (pipe weight + weight of the water + weight of the insulation), in accordance with the recognised codes of practice. See below table for pipe masses.

Dimension	Pipe mass	Pipe mass + water	Pipe mass + water + Iso 9 mm	Pipe mass + water + Iso 13 mm
mm	kg/m	kg/m	kg/m	kg/m
16 x 2,00	0,095	0,202	0,232	0,250
20 x 2,25	0,138	0,330	0,364	0,384
25 x 2,50	0,220	0,558	0,596	0,620
32 x 3,00	0,340	0,942	0,988	1,012
40 x 4,00	0,605	1,605	-	-
50 x 4,50	0,840	2,480	-	-
63 x 6,0	1,340	3,380	-	-
75 x 7,5	2,140	4,967	-	-

Table 5: Pipe masses.

3.7. Concealed installations

3.7.1. Pipes in screed or concrete

Due to the relatively low expansion forces, no compensation measures are required in the case of direct embedding of the pipes. Because of the slight plastic malleability of Wavin multi-layer composite pipes, the length changes are absorbed by the pipe wall. Moreover, the respective local regulations describing the minimum requirements regarding energy use of new and renovated buildings (e.g. EnEV 2016) and impact noise insulation must be observed.

Protection against corrosion

When fittings are exposed to aggressive media, like chlorides, ammonia, acids with $pH > 12,5$ or constantly exposed to moisture, fittings must be protected against corrosion by a sufficient covering, like protection tape (eg Denso).

When build into screed, concrete or plaster above conditions have to be considered and when applicable, protective measures must be taken.

3.7.2. Pipes in the floor construction

As multi-layer composite pipes can move axially within the insulation with little resistance, the expected length changes must be absorbed. Right angle diversions in the insulating

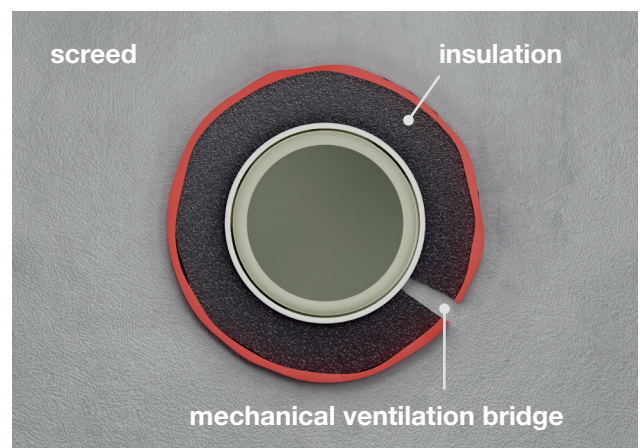

Fig 41: Mechanical vibration transmission through defective pipe insulation.

layer must be arranged such that length changes that occur in the respective sections are absorbed by the insulation thickness in the curve area.

Wavin Hot and Cold Water Systems already laid on the floor are exposed to many potential impacts on site during the construction phase, from scaffolding, ladders or other objects. Therefore caution must be exercised to prevent damage to the pipe/fitting or even the insulation. Before installing further floor construction, a check should therefore be conducted for damage. Any damage to the pipe insulation should be repaired in all cases in order to avoid the risk of the formation of impact noise bridges or reduced sound insulation.

Causes of damage in floating screeds are often due to several pipe strings being installed under the screed plate.

The following principles should be observed when installing pipe strings in the floor construction:

- ④ Use heat and sound insulated pipelines
- ④ Use sound insulated pipe fixing.
- ④ Avoid pipe crossings as much as possible
- ④ Install pipelines parallel to walls
- ④ Apply perpendicular junctions of pipelines into neighbouring walls
- ④ Reduce width of the pipe string to a maximum of 120 mm
- ④ Minimum distance between pipelines and walls:
 - ④ 200 mm in corridors
 - ④ 500 mm in the living area
- ④ For piping through screed expansion joints corrugated tube or alternatively 6 mm pipe insulation should be applied.
- ④ Fittings exposed to aggressive media or constantly exposed to moisture must be protected against corrosion by a sufficient covering

3.7.3. Pipelines installed under plaster

Depending on the wall construction and masonry strength, there is a risk that the expansion forces from a multi-layer composite pipe that is plastered-in directly, could cause damage to the wall. Multi-layer composite pipes under plaster should therefore be installed with insulation. This pipe insulation must be able to absorb expected length changes due to heat. In the case of pipelines under plaster for which there is no need for heat insulation, we recommend the use of the Wavin multi-layer composite pipe in black protective tube (see product range).

All pipes and fittings installed under plaster must be protected from direct contact with all building materials (such as masonry, plaster, cement, screed, tile adhesive) as detailed above.

3.7.4. Pipelines installed in exposed locations

Pipelines installed in exposed locations (e.g. basement pipes, risers etc) are fixed depending on the structural conditions and the recognised codes of practice. As appropriate, thermal length changes must be considered with the arrangement of bending joints in conjunction with fixed points and floating points as described in the previous chapter Length expansion and fixing.

3.8. Installation examples

3.8.1. Installation variants for drinking water

In this chapter you find four core installation examples of Tigris solutions in different situations. The right type of configuration will depend on the specific application area.

3.8.1.1. Single Tee installation



Fig. 42: Single Tee installation.

This type of installation should be used only when supplying to regularly and frequently used taps and fittings. Regularly and frequently here means “daily”. Tee connections result in single supply lines in which the drinking water can stagnate if it is not used.

Advantages:

- ⊕ Simple piping
- ⊕ Quick to install
- ⊕ Less piping used

Materials of Single Tee installation example







						
Tigris M5	Tigris M5	Tigris M5	Tigris M5	Tigris M5	Tigris MP	Tigris MP
Tee reduced 20 x 16 x 20	Tee 16 x 16 x 16	Holder pl. 153 16 x 1/2" anti-rot.	Wall Flange female 16 x 1/2"	Toilet connector	Pipe 20 mm	Pipe 16 mm
4064354	4064323	4064419	4064404	4064291	3004366	3004363

Table 6: Materials of Single Tee installation example.

3.8.1.2. In series installation



Fig. 43: In series installation.

In-series installation is suited to multi-storey installation with upstream water meters. The pipe is routed from one tapping point directly to the next. In-series installation is suited to multi-storey installation with upstream water meters. The pipe is routed from one tapping point directly to the next, using double connections. The tapping points are supplied by a common pipe. It should be ensured that the most frequently used fixture appears at the end of the in-series installation. WC flushing systems that can be set with a continuous, timed flush are available. These ensure that the entire cold-water piping on each storey is flushed, even when not in continuous use, for example in hotels. If required, flush valves for hot water piping are also available, with which a continuous, timed flush can be set.

Advantages:

- ⦿ Simple piping
- ⦿ No joints in screed
- ⦿ Time-saving, quick installation
- ⦿ Even pressure and heat distribution
- ⦿ Low stagnation volume
- ⦿ Rapid water exchange







						
Tigris M5	Tigris M5	Tigris M5	Tigris M5	Tigris M5	Tigris MP	Tigris MP
Tee reduced 20 x 16 x 20	Tee 16 x 16 x 16	U-Connector male 90° 16 x 1/2"	Double Wall Flange female 16 x 1/2"	Wall Flange female 16 x 1/2"	Pipe 20 mm	Pipe 16 mm
4064354	4064323	4064284	4064412	4064404	3004366	3004363

Table 7: Materials of In-series installation example.

3.8.1.3. Loop installation



Fig. 44: Loop installation.

The loop installation illustrated here is suited to multi-storey installation with upstream water meters. The pipe is routed from one tapping point directly to the next using double connections. The piping then runs from the last consumer back to the storey connection point.

Advantages:

- ⊕ Low pressure loss values (reduced by 50%)
- ⊕ Significantly more tapping points can be connected with the same pipe diameter
- ⊕ Greater distances for tapping are possible
- ⊕ Even pressure and heat distribution
- ⊕ Optimum water exchange with just one consumer's use
- ⊕ Low stagnation times

Loop installations with continuous hot water circulation should be sufficiently insulated.

The continuous maximal hot water temperature should be limited to 70 °C, according to ISO 21003.





					
Tigris M5	Tigris M5	Tigris M5	Tigris M5	Tigris MP	Tigris MP
Tee reduced 20 x 16 x 20	Tee 16 x 16 x 16	Double Wall Flange female 16 x 1/2"	Toilet connector	Pipe 20 mm	Pipe 16 mm
4064354	4064323	4064412	4064292	3004366	3004363

Table 8: Materials of loop installation example.

3.8.1.4. Loop installation with circulation connection

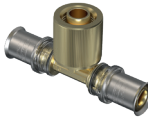

Fig. 45: Loop installation with circulation connection.

This type of loop installation is suitable for multi-storey installations without upstream water meters. The pipe is guided from one tapping point directly to the next using double connections. The piping then runs from the last cold water consumer back to the storey connection point. The hot water pipe is guided from the last fixture as a circulation pipe back to the storey connection point.

Advantages:

- ⦿ Lower pressure loss values for cold water section
- ⦿ All hot water tapping points feature a circulation connection. Even hot water temperature distribution
- ⦿ Optimum water exchange even when only one fixture is used
- ⦿ Low stagnation times
- ⦿ No legionella growth in the hot water tapping points
- ⦿ Hydraulic alignment of the circulation piping

Loop installations with continuous hot water circulation should be sufficiently insulated.

The continuous maximal hot water temperature should be limited to 70 °C, according to ISO 21003.





					
Tigris M5	Tigris M5	Tigris M5	Tigris M5	Tigris MP	Tigris MP
Tee reduced 20 x 16 x 20	Tee 16 x 16 x 16	Double Wall Flange female 16 x 1/2"	Toilet connector	Pipe 20 mm	Pipe 16 mm
4064354	4064323	4064412	4064292	3004366	3004363

Table 9: Materials of loop installation with circulation example.

3.8.1.5 Internal circulation

(check your representative for local availability)

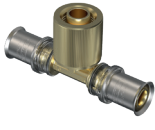
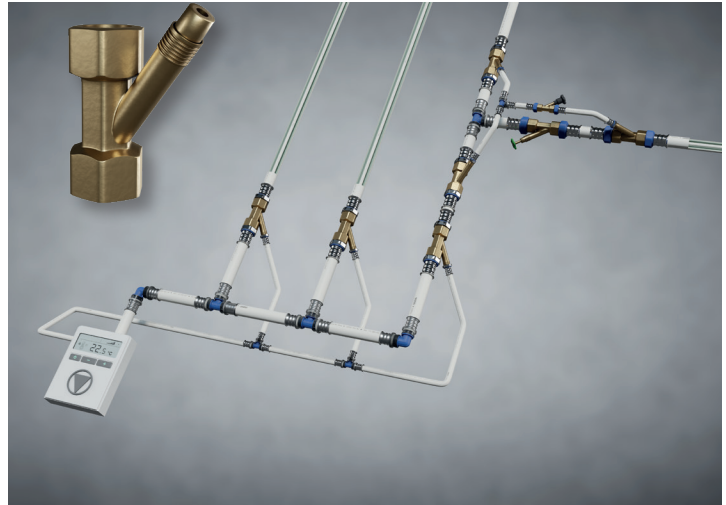
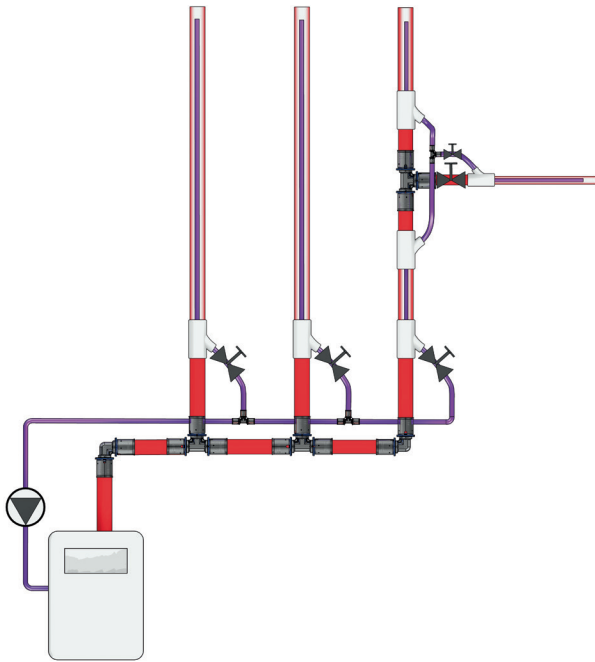

Fig. 46: Internal hot water circulation system.

Internal circulation is an efficient installation type offering various advantages. Basically, the circulation piping feeds into the hot water piping.

Advantages:

- ⦿ Less space required in the duct
- ⦿ No separate fixings
- ⦿ No separate insulation
- ⦿ No separate fire protection. Less material required
- ⦿ No additional loss of energy through external circulation
- ⦿ Optimum hygiene
- ⦿ Can be retrofitted into existing installations (depending on standing pipe dimension)

Tip: Internal circulation: quick, energy-efficient, can be retrofitted.

Note for calculating the size:

With internal circulation, the selected existing pipe generally has to be one size bigger than the calculation. The Wavin connection set is available on request.

Loop installations with continuous hot water circulation should be sufficiently insulated. The continuous maximal hot water temperature should be limited to 70 °C, according to ISO 21003.

Wavin offers pre-assembled connection sets for internal circulation. The Wavin connection sets comprise:

- ⦿ Wavin internal circulation pipe PE-Xc, in 8 mm or 12 mm.
- ⦿ Wavin multi-layer composite pipe.
- ⦿ Tigris K5 and Tigris M5 pre-form parts (incl. pre-form parts with sleeve as transition to internal circulation pipe).
- ⦿ Thermostat valve with default setting for circulation piping.
- ⦿ Phase regulation and isolation valve.

Tigris Inliner connection sets Cat. code

40 x 32 mm 03171473

50 x 32 mm 03171474

Individual parts Cat. code

Tigris Inliner pipe PE-Xc 8 mm 03171472

Tigris Inliner pipe PE-Xc 12 mm 03171471

Tigris M1 Inliner fitting 1" x 3/4" 8 mm 03171469

Tigris M1 Inliner fitting 1 1/2" x 3/4" 12 mm 03171470

3.8.2. Heating installation Variants



Fig. 47: Double pipe radiator heating.

In this chapter you find the most common examples of Tigris radiator solutions

1. Double pipe heating

The “standard variant” – recognized, tried and tested

Economically sensible terms and conditions of service

Because of the total length of the pipe network resulting in pressure loss, a pressure loss of 100 to 200 Pa/m can be calculated in consideration of additional individual resistances (e.g. valves).

The advantages:

- ⦿ Even temperature of all radiators (= source of well being)
- ⦿ Recognised system for recording heating costs
- ⦿ Suitable for skirting boards

2. Double pipe heating with central manifold

The “spaghetti system” – optimal assembly and comfort

Economically sensible terms and conditions of service

Because of the short connection pipes from the manifold to the individual radiators, a pressure loss of 240 to 400 Pa/m can be calculated in consideration of additional individual resistances (e.g. valves).

The advantages:

- ⦿ Only one pipe dimension from the manifold
- ⦿ No connecting points in the floor area
- ⦿ Each radiator feed line can be operated autonomously.
- ⦿ No circulation in the pipe system in case of radiator stoppage (energy saving)

3. Single pipe heating

The “saving variant” – quick and inexpensive

Economically sensible terms and conditions of service

Because of the total length of the main line resulting in pressure loss in the case of single pipe heating, a pressure loss of 100 to 200 Pa/m should be expected in consideration of additional individual resistances (sub-pipes branching off of the main line or z values of 4-way valves).

With the use of 4-way valves:

- ⦿ No connecting points in the floor area
- ⦿ Extremely quick installation
- ⦿ Only one pipe dimension from the line connection

3.8.3. Radiator connection: installation Variants

The Wavin Tigris K5/M5 and smartFIX systems offer many options for the connection of standard compact and valve radiators in the single pipe and double pipe system. The following diagrams show the most popular connection variants. In all cases, the insulation must be taken into account in accordance with the energy saving regulation.

3.8.3.1. Compact Radiators

Pipe connection from the wall by means of Eurocone screw connections.



Tigris M1

Eurocone Screw connection FT 16 x 3/4"

4013466

Fig. 48: Radiator installation examples with “Eurocone” screw connection.

3.8.3.2. Valve Radiators

Pipe connection from the wall by means of radiator connecting block and IT “Eurocone” screw connections and the use of a junction fitting.



Fig. 49: Radiator installation examples with cross-fitting block.

		Also available in:	
Tigris M1	Tigris M5	16x16x20	16x20x16
Eurocone Screw connection FT 16 x 3/4"	Cross fitting 16x16x16	20x16x16	20x16x20
4013466	4064422	20x20x16	20x20x20

Pipe connection from the floor by means of Tigris M1 angle connecting pipes.

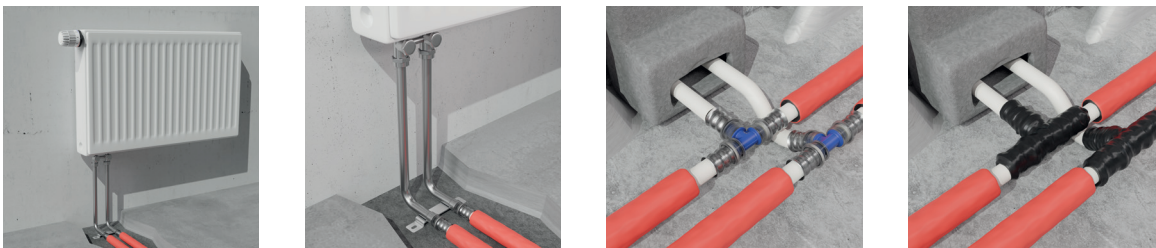

Fig. 50: Radiator installation examples with angle connection pipes.

Remark- Always protect fittings from corrosion when immersed in concrete.

			
Tigris M5	Tigris M5	Tigris M5	Tigris M5
radiator wall	radiator floor	elbow radiator	tee radiator
4064242	4064243	4064239	4064240

Table 10: Materials of radiator installation

4. Technical information

4.1. Technical specifications

4.1.1. Technical specifications MP Pipes

Wavin multi-layer composite pipes: Technical specifications

Range of application Drinking water installation, radiator connections and underfloor heating

Pipe colour white



Pipe material	PE-Xc pipes Internal layer made of PE-Xc (electron-beam crosslinked polyethylene), external layer made of PE, with an aluminium layer between, connected by special bounding agents	PE-RT pipes Internal layer made of PE-RT (raised temperature resistance polyethylene), external layer made of PE, with an aluminium layer between, connected by special bounding agents	
Classification fire behaviour	DIN EN 13501: E DIN 4102: B2	DIN EN 13501: E DIN 4102: B2	
Application conditions	Application class 1 2 4 5	Design temp. 60°C 70°C 20-40-60°C 20-40-80°C	Design pressure 10 bar 10 bar 10 bar 6 bar
Coefficient of thermal expansion	0,025 – 0,030 mm/m·K		
Thermal conductivity	0,4 W/ m·K		
Pipe roughness	0,007mm		
Range of application	Low temperature radiator connections and underfloor heating systems		
Pipe colour	blue		
Pipe material	Internal layer made of PE-RT (raised temperature resistance polyethylene), external layer made of PE, with an aluminium layer between, connected by special bounding agents		
Application conditions	Application class 4	Design temp. 20-40-60°C	Design pressure 10 bar
Coefficient of thermal expansion	0,025 – 0,030 mm/m·K		
Thermal conductivity	0,4 W/ m·K		
Pipe roughness	0,007mm		

Table 11: Technical specifications of Wavin multi-layer composite pipes .

4.1.2. Technical specifications Fittings

Technical specifications Tigris K5 and Tigris M5



	Tigris K5 (16-40 mm)	Tigris M5 (16-40 mm)
Fitting material	Polyphenylsulfone (PPSU body), press sleeve in stainless steel, threaded inserts: Ecobrass (CW724R)	Brass body (CW 617N/ CW625N/ CW 724R), press sleeve in stainless steel
Fitting colour	Blue fitting and transparent fixring 	Brass-coloured body and transparent fixring 
Max. constant operating temperature	85°C at 6 bar, 70°C at 10 bar	
Max. short-term load	100°C (at max. 100 hours in 50 years)	
Max. constant operating pressure	10 bar at 70°C	

Table 12: Technical specifications of Tigris K5 and Tigris M5.

Technical specifications Tigris K1 and Tigris M1



	Tigris K1 (50-75)	Tigris M1 (50-75)
Fitting material	Polyphenylsulfone (PPSU), press sleeve in stainless steel, threaded inserts: Ecobrass (CW724R)	Tin-coated brass (CW617N), press sleeve in stainless steel
Fitting colour	Blue 	Base body tin plated and blue fixring 
Max. constant operating temperature	85°C at 6 bar, 70°C at 10 bar	
Max. short-term load	100°C (at max. 100 hours in 50 years)	
Max. constant operating pressure	10 bar at 70°C	

Table 13: Technical specifications of Tigris K1 and Tigris M1.

Technical specifications smartFIX

smartFIX

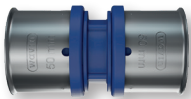
Fitting material	Polyphenylsulfone (PPSU) for the fitting base body and fixing ring. Caps in glass fibre reinforced polyamide. Threaded inserts: Ecobrass (CW724R)
Fitting colour	Blue
	
Max. constant operating temperature	85°C at 6 bar, 70°C at 10 bar
Max. short-term load	100°C (at max. 100 hours in 50 years)
Max. constant operating pressure	10 bar at 70°C

Table 14: Technical specifications of Tigris smartFIX.

4.1.3. Classification of operating requirements for Wavin Multi layer pipe following ISO 21003-1:2008 (E)

Temperature

ISO 21003 disguises the following temperatures:

- ⦿ T_D = Design temperature, maximum exposure 49 years *
- ⦿ T_{max} = Maximum temperature, max. exposure 1 year **
- ⦿ T_{mal} = Malfunction temperature, max. exposure 100 hours

In total summing up a lifetime of 50 years.

The **most relevant is the design temperature**, as this indicates what maximum temperature can be exposed on the pipe on a daily base.

This continuous maximum operating temperature should not exceed 70°C.

When loop circulation is applied for hot water, it is strongly recommended to apply sufficient pipe insulation.

This temperature is mentioned on the pipe between brackets and is directly related to the class. Example: c1(60°C) means application class 1 (hot water supply), design temperature 60°C.

(T_{max} 95°C on the pipe refers to the required max. temperature during the Temperature Cycle Test which is executed to simulate a lifetime of 50 years).

Application class & pressure

ISO 21003 disguises the following application classes:

- ⦿ Class 1 for hot water supply up to 60°C
- ⦿ Class 2 for hot water supply up to 70°C
- ⦿ Class 4 for low-temperature (underfloor) heating/ radiators
- ⦿ Class 5 for high-temperature heating/ radiators

With the application class, the following design pressures are defined:

4 bar, 6 bar, 8 bar, 10 bar.

The pressure class is defined by the pipe configuration: material(s), wall thickness and diameter.

Example: **c15(80°C)/6 bar(0,6 Mpa)** means application class 5 (= high-temperature heating), design temperature.

Class	Design temp.	Years T _D	Years T _{max}	T _{mal}	Hours T _{mal}	Application
1	60 °C	49	1	95 °C	100	Hot water 60 °C
2	70 °C	49	1	95 °C	100	Hot water 70 °C
4	20-40-60 °C*	2,5-20-25*	2,5	100 °C	100	HLow temp. heating
5	20-60-80 °C*	14-25-10*	1	100 °C	100	High temp. heating

*) TD for UFH/ low temp. radiators = 60°C/ 25 years + 40°C/ 20 year + 20°C/ 2,5 year. For high temp. radiators = 80°C/ 10 years + 60°C/ 25 year + 20°C/ 14 year

**) Tmax for UFH/ low temp. radiators max. exposure = 2,5 years

Table 15: Application class according to ISO 21003-1:2008.

4.2 Flow performance

The performance of the installation is related to the pressure loss in the system and the final water flow at the tap point. One of the causes of pressure loss in the systems is related to internal diameters of pipe as well as inner bore of the fitting. The impact of the inner bore (reduction) versus pipe inside diameter is stronger for smaller diameters than with bigger diameters.

With Tigris M5 and Tigris K5, covering the fitting range up to 40 mm, the increase of the bore diameter has significantly contributed to an improvement of flow performance. That's what we call Optiflow.

In below overview the Zeta values of the various fittings and diameters can be found.

4.2.1. Zeta values Tigris M5 & Tigris K5

A water velocity of 2 m/s has been used for the calculation of equivalent pipe lengths:

Nr.	Designation according to DVGW W 575	Graphic symbol according to DVGW W 575 ¹⁾	Zeta value ξ			
			DN 12	DN 15	DN 20	DN 25
			pipe diameter d_a mm			
			16	20	25	32
1	TA		7,8	5,4	3,9	3,2
2	TD		2,5	1,4	0,8	0,6
3	TG		7,0	5,0	4,1	2,7
4	TVA		13,4	9,3	8,1	5,4
5	TVD		27,4	19,3	13,3	11,2
6	TVG		18,9	11,7	12,8	9,8
7	W90		6,4	5,4	3,7	3,0
8	W45		-	-	1,6	1,3
9	RED		-	2,6	0,8	0,7
10	WS		5,7	4,9	5,2	-
11	WSD		9,0	6,0	3,8	-
12	WSA		7,0	12,2	9,8	-
13	STV		-	-	-	-
14	K		2,2	1,1	0,8	0,5

Remark: The Zeta values of Tigris K1, Tigris K5, Tigris M1, Tigris M5 and smartFIX can by exception deviate of the values mentioned in the above table according to DIN 1988- part 300. On request, the specific values can be submitted. The values in the table are the measured values for Tigris M5. These values might only be used indicatively for Tigris K5.

Table 16: Zeta values Tigris K5 and Tigris M5 and equivalent pipe lengths.

4.2.2. Zeta values Tigris M1 & Tigris K1

A water velocity of 2 m/s has been used for the calculation of equivalent pipe lengths:

Nr.	Abbreviation according to DVGW W 575	Graphic symbol according to DVGW W 575 ¹⁾	Zeta value ξ								
			DN 12	DN 15	DN 20	DN 25	DN 32	DN 40	DN 50	DN 65	
			pipe diameter d_a mm					50	63	75	
1	TA		17,2	8,1	5,6	9,3	3,5	3,0	3,1	4,1	
2	TD		6,0	3,6	2,1	4,8	1,1	0,8	0,7	0,8	
3	TG		11,5	6,8	5,3	3,7	3,5	3,0	3,1	4,1	
4	TVA		17,0	10,0	8,0	5,0	5,5	4,5	4,0	3,5	
5	TVD		35,0	23,0	16,0	11,0	10,0	9,0	8,0	7,0	
6	TVG		27,0	17,0	12,0	9,0	8,0	7,0	6,0	5,0	
7	W90		17,3	7,4	5,7	8,3	3,3	3,0	3,5	4,0	
8	W45		3,0	2,5	2,0	1,5	1,3	1,0	1,0	1,0	
9	RED		3,1	2,6	2,0	1,0	0,6	1,3	0,3	0,5	
10	WS		8,1	6,6	-	-	-	-	-	-	
11	WSD		5,0	4,5	4,0	-	-	-	-	-	
12	WSA		4,0	3,5	3,0	-	-	-	-	-	
13	STV		4,5	3,0	-	-	-	-	-	-	
14	K		3,1	3,5	2,1	5,0	0,9	0,9	0,9	0,7	

Remark: The Zeta values of Tigris K1, Tigris K5, Tigris M1, Tigris M5 and smartFIX can by exception deviate of the values mentioned in the above table according to DIN 1988- part 300. On request, the specific values can be submitted.

Table 17: Zeta values Tigris K1 and Tigris M1 and equivalent pipe lengths according to DIN 1988- part 300.

4.2.3. Pressure loss in pipes for drinking water applications

Drinking water,
nominal dimensions 16-25 mm

Normal dimension (V/l)	16 x 2 mm 12 mm 0,11 l/m		20 x 2,25 mm 15,5 mm 0,19 l/m		25 x 2,5 mm 20 mm 0,31 l/m		
	Vs l/s	R mbar/m	v m/s	R mbar/m	v m/s	R mbar/m	v m/s
0,01		0,24	0,12				
0,02		0,80	0,19	0,24	0,15		
0,03		1,39	0,29	0,49	0,18		
0,04		2,26	0,37	0,77	0,23	0,26	0,18
0,05		3,40	0,45	0,98	0,26	0,29	0,20
0,06		4,43	0,55	1,29	0,31	0,34	0,22
0,07		5,80	0,63	1,84	0,39	0,52	0,24
0,08		7,40	0,73	2,25	0,45	0,74	0,26
0,09		8,90	0,82	2,38	0,50	0,84	0,30
0,10		10,81	0,91	3,31	0,54	0,99	0,33
0,15		22,00	1,35	6,51	0,81	2,00	0,49
0,20		37,40	1,81	11,01	1,10	3,30	0,65
0,25		61,24	2,44	15,48	1,31	4,40	0,79
0,30		81,29	2,87	23,70	1,63	6,47	0,97
0,35		104,30	3,34	28,94	1,83	8,35	1,10
0,40		131,80	3,73	41,05	2,17	10,47	1,29
0,45		157,80	4,43	44,04	2,34	13,40	1,44
0,50		191,20	4,84	54,03	2,71	15,70	1,58
0,55		229,40	5,11	71,02	2,96	19,34	1,79
0,60		261,30	5,52	79,60	3,24	21,99	1,94
0,65		299,70	5,91	91,10	3,51	25,30	2,09
0,70		333,76	6,41	99,90	3,77	29,01	2,22
0,75		378,13	6,85	115,40	4,00	33,40	2,41
0,80		425,31	7,26	122,30	4,19	35,70	2,51
0,85				137,20	4,46	39,90	2,67
0,90				154,70	4,80	43,15	2,73
0,95				171,50	5,10	49,10	3,04
1,00				190,40	5,33	52,80	3,11
1,05				208,30	5,60	63,01	3,38
1,10				217,90	5,87	67,40	3,53
1,15				229,40	5,99	70,01	3,70
1,20				243,60	6,27	74,40	3,85
1,25				281,10	6,70	77,20	4,10
1,30				299,40	6,99	81,03	4,32
1,35						86,21	4,50
1,40						99,13	4,62
1,45						101,90	4,84
1,50						103,80	4,99

Table 18: Pressure loss in Wavin Tigris multilayer pipes in the drinking water installation.

Drinking water, nominal dimensions 32-50 mm

Normal dimension (V/l)	32 x 3 mm 25 mm 0,53 l/m		40 x 4 mm 32 mm 0,80 l/m		50 x 4,5 mm 41 mm 1,32 l/m	
	Vs l/s	R mbar/m	v m/s	R mbar/m	v m/s	R mbar/m
0,07	0,21	0,13				
0,08	0,24	0,14				
0,09	0,26	0,16				
0,10	0,31	0,19				
0,15	0,58	0,27	0,27	0,19		
0,20	1,10	0,41	0,35	0,27		
0,25	1,31	0,48	0,55	0,31	0,19	0,18
0,30	1,80	0,56	0,70	0,38	0,25	0,23
0,35	2,51	0,68	0,88	0,42	0,31	0,27
0,40	3,10	0,76	1,14	0,49	0,36	0,32
0,45	3,65	0,85	1,35	0,54	0,45	0,33
0,50	4,45	0,95	1,67	0,60	0,54	0,38
0,55	5,20	1,03	1,99	0,69	0,63	0,41
0,60	6,21	1,14	2,32	0,77	0,70	0,45
0,65	7,01	1,22	2,34	0,81	0,82	0,51
0,70	7,99	1,29	2,99	0,84	0,95	0,55
0,75	9,05	1,40	3,38	0,90	1,08	0,57
0,80	10,64	1,53	3,77	0,97	1,17	0,60
0,85	11,17	1,59	4,38	1,06	0,27	0,62
0,90	13,25	1,72	4,73	1,13	1,43	0,65
0,95	13,73	1,78	5,24	1,19	1,66	0,72
1,00	15,11	1,87	5,65	1,25	1,77	0,79
1,10	18,14	2,06	6,73	1,38	2,07	0,84
1,20	20,99	2,25	7,77	1,47	2,35	0,87
1,30	24,40	2,44	9,04	1,65	2,72	0,96
1,40	27,47	2,65	10,31	1,78	3,16	1,05
1,50	31,20	2,83	11,67	1,91	3,59	1,16
1,60	35,90	3,09	12,98	1,97	4,02	1,24
1,70	39,99	3,21	14,37	2,09	4,61	1,41
1,80	43,71	3,41	16,09	2,26	5,01	1,49
1,90	46,98	3,55	17,57	2,35	5,45	1,65
2,00	54,20	3,81	19,31	2,47	5,99	1,72
2,20	69,27	4,22	23,11	2,78	7,02	1,81
2,40	78,00	4,61	27,01	3,01	8,25	1,89
2,60	87,20	4,94	31,02	3,29	9,45	2,04
2,80	93,34	5,04	35,19	3,46	10,91	2,21
3,00	121,30	3,31	40,04	3,78	12,25	2,31
3,20			45,57	3,99	13,55	2,56
3,40			50,88	4,06	14,48	2,74
3,60			56,17	4,51	18,02	2,99
4,00			66,87	4,94	20,54	3,14
4,20			71,14	5,23	21,74	3,29
4,40			79,14	5,41	23,08	3,47
4,60			85,77	5,66	27,25	3,71
4,80			93,23	5,91	28,88	3,88
5,00			107,12	6,13	30,67	3,89
5,20					32,19	4,02
5,40					33,33	4,08
5,60					34,12	4,12
5,80					39,68	4,33
6,00					43,44	4,56

Drinking water, nominal dimensions 63-75 mm

Normal dimension (V/l)	63 x 6,0 mm 51 mm		75 x 7,5 mm 60 mm	
	Vs l/s	R mbar/m	v m/s	R mbar/m
1,00	0,63	0,50	0,27	0,35
1,10	0,74	0,55	0,31	0,39
1,20	0,89	0,59	0,37	0,42
1,30	1,13	0,63	0,42	0,46
1,40	1,21	0,68	0,48	0,50
1,50	1,26	0,75	0,54	0,53
1,60	1,49	0,78	0,61	0,57
1,70	1,60	0,82	0,68	0,60
1,80	1,76	0,89	0,75	0,64
1,90	1,92	0,95	0,83	0,67
2,00	2,10	1,00	0,90	0,71
2,20	2,60	1,12	1,07	0,78
2,40	2,80	1,20	1,25	0,85
2,60	3,20	1,26	1,44	0,92
2,80	3,60	1,35	1,65	0,99
3,00	4,30	1,48	1,86	1,06
3,20	4,90	1,60	2,09	1,13
3,40	5,60	1,70	2,33	1,20
3,60	6,60	1,85	2,58	1,27
4,00	7,20	2,00	3,12	1,41
4,20	8,00	2,10	3,40	1,49
4,40	9,00	2,20	3,70	1,56
4,60	9,40	2,30	4,01	1,63
4,80	9,70	2,40	4,33	1,70
5,00	10,80	2,50	4,66	1,77
5,20	11,00	2,58	5,00	1,84
5,40	11,60	2,62	5,35	1,91
5,60	12,40	2,73	5,71	1,98
5,80	13,80	2,85	6,09	2,05
6,00	15,00	2,94	6,47	2,12
6,25			6,96	2,21
6,50			7,48	2,30
6,75			8,01	2,39
7,00			8,55	2,48
7,25			9,11	2,56
7,50			9,69	2,65
7,75			10,28	2,74
8,00			10,89	2,83
8,50			12,16	3,01
9,00			13,49	3,18
9,50			14,89	3,36
10,00			16,34	3,54

4.2.4. Pressure loss in heating systems

Dimensioning heating systems

For Wavin multi-layer composite pipes installed with Tigris K1, Tigris K5, Tigris M1, Tigris M5 and smartFIX fittings, the aluminum layer guarantees tightness against oxygen diffusion and thus meets the requirements of DIN 4726 (hot water, underfloor heating and central heating)in terms of oxygen tightness.

This makes the Tigris connection system particularly suitable for these heating applications.

The design and calculation of the required pipe diameter can be done in accordance with the relevant technical design rules, determined by the amount of heat to be transported and the applicable pressure losses in the pipe network.

The pressure loss in a pipe network is caused by the pipe friction for the selected pipe diameter and the Sum of individual resistances such as angles, tees, radiators,

Connection angle

The pipe friction losses of Wavin Tigris-K1, Tigris-M1 and smartFIX pipes can be found on the tables on the next pages. By selecting an inlet/ return temperature difference of 10, 15 or 20 K, the pressure loss in Pa/m as well as the speed can be determined directly.

Formulas:

Sum of individual pressure losses:

$$Z = \sum \zeta \frac{v^2 \cdot \rho}{2} \text{ [Pa]}$$

ζ = Pressure loss Coefficient (Zeta value)

ρ = Density (kg/m³)

v = Velocity (m/s)

Total pressure loss:

$$\Delta p_g = R \cdot l + Z + \Delta p_v \text{ [Pa]}$$

R = Pressure loss in pipe (Pa/m)

l = pipe length (m)

Z = individual pressure loss

Δp_v = Pressure loss heating valve (Pa)

Heating medium mass flow:

$$m = \frac{Q_{HK}}{\Delta t \cdot C} \text{ [kg/h]}$$

Q_{HK} = heat quantity heating circuit (W)

Δt = Temperatur difference inlet/ return (K)

C = specific heat capacity water

= (1,163 Wh/kg · K)

**Pressure loss in multi layer pipes
for heating systems**

Diameters 16-32 mm

Mass flow kg/h	Heatperformance W			Pipe dimensions mm			
	with a delta of (K)			Pressure loss R (Pa/m) + Velocity v (m/s)			
	10	15	20	16 x 20 d _i = 12		20 x 2,25 d _i = 15,5	
				R	v	R	v
8,59	100	150	200	1	0,02		
12,89	150	425	300	3	0,03		
17,19	200	300	400	5	0,04		
21,49	250	375	500	8	0,05		
25,79	300	450	600	10	0,06		
30,09	350	525	700	13	0,09		
34,39	400	600	800	16	0,10		
38,69	450	675	900	19	0,11		
42,99	500	750	1000	22	0,12		
51,59	600	900	1200	30	0,13		
60,18	700	1050	1400	35	0,14		
68,78	800	1200	1600	50	0,16		
77,38	900	1375	1800	61	0,20		
85,98	1000	1500	2000	66	0,21	11	0,10
94,58	1100	1650	2200	81	0,23	18	0,12
103,18	1200	1800	2400	93	0,26	25	0,14
111,76	1300	1950	2600	111	0,29	31	0,16
120,36	1400	2100	2800	119	0,30	38	0,18
128,96	1500	2250	3000	144	0,33	46	0,20
137,56	1600	2400	3200	156	0,35	51	0,22
146,16	1700	2550	3400	177	0,38	58	0,24
154,76	1800	2700	3600	190	0,39	63	0,25
171,96	2000	3000	4000	225	0,43	70	0,27
180,57	2100	3150	4200	247	0,44	79	0,28
189,17	2200	3300	4400	268	0,46	86	0,29
197,76	2300	3450	4600	289	0,49	93	0,30
206,36	2400	3600	4800	320	0,52	98	0,31
214,96	2500	3750	5000	345	0,56	103	0,32
223,56	2600	3900	5200	353	0,58	107	0,34
232,16	2700	4050	5400	365	0,61	112	0,35
240,76	2800	4200	5600	422	0,63	121	0,37
249,36	2900	4350	5800	453	0,65	130	0,39
257,95	3000	4500	6000	471	0,67	140	0,40
266,55	3100	4650	6200	506	0,69	152	0,42
275,15	3200	4800	6400	545	0,71	161	0,43
283,75	3300	4950	6600	587	0,74	167	0,45
292,35	3400	5100	6800	603	0,76	175	0,46
300,94	3500	5250	7000	625	0,77	185	0,47
309,54	3600	5400	7200	663	0,79	199	0,48
318,14	3700	5550	7400	696	0,82	211	0,50
326,74	3800	5700	7600	732	0,83	218	0,51
335,34	3900	5850	7800	765	0,86	226	0,53
343,93	4000	6000	8000	781	0,88	235	0,54
386,93	4500	6250	9000	966	0,98	277	0,61
408,43	4750	7125	9500	1088	1,04	304	0,63
429,92	5000	7500	10000	1067	1,11	351	0,66
451,42	5250	7875	10500			374	0,70
472,91	5500	8250	11000			409	0,72
494,41	5750	8625	11500			439	0,75
515,90	6000	9000	12000			470	0,78
537,40	6250	9375	12500			512	0,83
558,90	6500	9750	13000			545	0,85
580,40	6750	10125	13500			581	0,88
601,89	7000	10500	14000			619	0,91
623,39	7250	10875	14500			666	0,96
644,88	7500	11250	15000			699	0,98
666,38	7750	11625	15500			744	1,01
687,87	8000	12000	16000			786	1,04
709,37	8250	12375	16500			829	1,08
730,87	8500	12750	17000			887	1,11
773,86	9000	13500	18000			987	1,17
795,36	9250	13875	18500			1019	1,21

Table 19: Mass flow, heat performance and pressure loss for Wavin Tigris multilayer Pipes.

Mass flow kg/h	Heatperformance W			Pipe dimensions mm			
				25 x 2,5 d _i = 20		32 x 3,0 d _i = 26	
	with a delta of (K)			Pressure loss R (Pa/m) + Velocity v (m/s)			
	10	15	20	R	v	R	v
171,96	2000	3000	4000	21	0,15		
189,17	2200	3300	4400	25	0,17		
206,36	2400	3600	4800	29	0,18		
214,96	2500	3750	5000	30	0,19		
232,16	2700	4050	5400	34	0,21		
249,36	2900	4350	5800	38	0,22		
257,95	3000	4500	6000	41	0,24	12	0,150
275,15	3200	4800	6400	45	0,25	13	0,156
292,35	3400	5100	6800	51	0,26	15	0,165
300,95	3500	5250	7000	54	0,27	16	0,170
318,14	3700	5550	7400	60	0,29	17	0,176
335,34	3900	5850	7800	66	0,30	19	0,185
343,94	4000	6000	8000	69	0,31	20	0,190
365,43	4250	6375	8500	77	0,33	22	0,200
386,93	4500	6750	9000	85	0,35	24	0,210
408,43	4750	7125	9500	93	0,37	26	0,220
429,92	5000	7500	10000	102	0,39	29	0,230
451,42	5250	7875	10500	108	0,42	32	0,240
472,91	5500	8250	11000	120	0,44	35	0,250
494,41	5750	8625	11500	130	0,46	38	0,260
515,91	6000	9000	12000	140	0,47	41	0,280
537,40	6250	9375	12500	150	0,48	44	0,290
558,90	6500	9750	13000	160	0,50	47	0,300
580,40	6750	10125	13500	171	0,52	50	0,310
601,89	7000	10500	14000	183	0,54	53	0,320
623,39	7250	10875	14500	194	0,56	56	0,330
644,88	7500	11250	15000	206	0,58	59	0,340
666,38	7750	11625	15500	218	0,61	62	0,370
687,88	8000	12000	16000	231	0,63	66	0,380
709,37	8250	12375	16500	244	0,65	70	0,390
730,87	8500	12750	17000	257	0,68	74	0,400
752,36	8750	13125	17500	270	0,70	78	0,410
773,86	9000	13500	18000	284	0,71	82	0,420
795,36	9250	13875	18500	297	0,71	86	0,430
816,85	9500	14250	19000	312	0,72	90	0,440
838,35	9750	14625	19500	327	0,74	94	0,450
859,85	10000	15000	20000	343	0,76	98	0,460
881,34	10250	15375	20500	357	0,78	102	0,470
902,84	10500	15750	21000	374	0,79	107	0,480
924,34	10750	16125	21500	390	0,83	112	0,490
945,83	11000	16500	22000	406	0,84	116	0,500
967,33	11250	16875	22500	422	0,85	121	0,520
988,83	11500	17250	23000	439	0,87	126	0,530
1010,32	11750	17625	23500	456	0,93	131	0,540
1031,82	12000	18000	24000	473	0,94	136	0,550
1053,31	12250	18375	24500	490	0,95	141	0,560
1074,81	12500	18750	25000	508	0,98	146	0,570
1096,31	12750	19125	25500	526	0,99	151	0,580
1117,80	13000	19500	26000	544	1,02	156	0,600
1139,29	13250	19875	26500	562	1,04	161	0,61
1160,79	13500	20250	27000	580	1,05	167	0,62
1182,28	13750	20625	27500	598	1,07	172	0,63
1203,78	14000	21000	28000	616	1,10	177	0,65
1225,27	14250	21375	28500	634	1,11	183	0,66
1246,77	14500	21750	29000	653	1,12	189	0,67
1289,76	15000	22500	30000	672	1,13	201	0,69

Mass flow kg/h	Heatperformance W			Pipe dimensions mm			
				25 x 2,5 d _i = 20		32 x 3,0 d _i = 26	
	with a delta of (K)			Pressure loss R (Pa/m) + Velocity v (m/s)			
	10	15	20	R	v	R	v
1332,76	15500	23250	31000			213	0,71
1375,75	16000	24000	32000			225	0,73
1418,74	16500	24750	33000			237	0,76
1461,73	17000	25500	34000			250	0,79
1504,73	17500	26250	35000			261	0,81
1547,72	18000	27000	36000			277	0,84
1590,71	18500	27750	37000			291	0,86
1633,70	19000	28500	38000			305	0,88
1676,69	19500	29250	39000			319	0,90
1719,69	20000	30000	40000			334	0,92
1762,68	20500	30750	41000			349	0,94
1805,67	21000	31500	42000			364	0,96
1848,66	21500	32250	43000			380	0,99
1891,65	22000	33000	44000			396	1,02

Table 19: Mass flow, heat performance and pressure loss for Wavin Tigris multilayer Pipes.

**Pressure loss in multi layer pipes
for heating systems**

Diameters 40-75 mm

Mass flow kg/h	Heatperformance W			Pipe dimensions mm							
				40x4,0 d _i = 32		50 x 4,5 d _i = 41		63 x 6,0 d _i = 51		75 x 7,5 d _i = 60	
	with a delta of (K)			Pressure loss R (Pa/m) + Velocity v (m/s)							
	10	15	20	R	v	R	v	R	v	R	v
859,84	10000	15000	20000	37	0,30	12	0,19	4	0,13	2	0,09
945,82	11000	16500	22000	44	0,33	14	0,21	5	0,14	3	0,09
1031,81	12000	18000	24000	52	0,36	16	0,23	6	0,15	3	0,10
1117,79	13000	19500	26000	59	0,39	18	0,25	7	0,16	4	0,11
1203,78	14000	21000	28000	67	0,42	21	0,27	8	0,17	4	0,12
1289,76	15000	22500	30000	75	0,45	24	0,29	9	0,18	4	0,13
1375,75	16000	24000	32000	84	0,48	27	0,30	10	0,19	5	0,14
1461,73	17000	25500	34000	94	0,51	30	0,32	11	0,21	6	0,15
1547,72	18000	27000	36000	104	0,54	33	0,34	12	0,22	6	0,16
1633,70	19000	28500	38000	114	0,58	36	0,36	13	0,23	7	0,16
1719,69	20000	30000	40000	124	0,62	39	0,38	14	0,24	7	0,17
1805,67	21000	31500	42000	136	0,65	42	0,39	15	0,25	8	0,18
1891,65	22000	33000	44000	148	0,68	45	0,41	16	0,26	9	0,19
1977,64	23000	34500	46000	160	0,71	49	0,43	18	0,27	9	0,20
2063,62	24000	36000	48000	172	0,74	53	0,45	20	0,29	10	0,21
2149,61	25000	37500	50000	185	0,77	57	0,47	21	0,30	11	0,22
2235,59	26000	39000	52000	199	0,80	61	0,49	22	0,31	12	0,22
2321,58	27000	40500	54000	213	0,83	65	0,50	24	0,32	12	0,23
2407,56	28000	42000	56000	227	0,86	69	0,52	25	0,33	13	0,24
2493,55	29000	43500	58000	241	0,89	74	0,54	26	0,34	14	0,25
2579,53	30000	45000	60000	255	0,92	79	0,56	27	0,35	15	0,26
2665,52	31000	46500	62000	271	0,95	83	0,58	29	0,36	16	0,27
2751,50	32000	48000	64000	287	0,98	88	0,60	33	0,38	17	0,28
2837,48	33000	49500	66000	303	1,01	93	0,62	34	0,39	18	0,28
2923,47	34000	51000	68000	319	1,04	98	0,64	35	0,40	19	0,29
3009,45	35000	52500	70000	335	1,07	103	0,66	37	0,41	19	0,30
3095,44	36000	54000	72000	353	1,10	108	0,67	38	0,42	20	0,31
3181,42	37000	55500	74000	371	1,13	113	0,69	40	0,44	21	0,32
3267,41	38000	57000	76000	389	1,16	119	0,71	44	0,45	22	0,33
3353,39	39000	58500	78000	407	1,19	125	0,73	46	0,46	24	0,34
3439,38	40000	60000	80000	426	1,22	131	0,75	47	0,47	25	0,34
3525,36	41000	61500	82000	446	1,25	137	0,77	49	0,48	26	0,35
3611,34	42000	63000	84000	465	1,28	143	0,78	52	0,50	27	0,36
3697,33	43000	64500	86000	485	1,31	149	0,80	54	0,51	28	0,37
3783,31	44000	66000	88000	505	1,34	155	0,82	56	0,52	29	0,38
3869,30	45000	67500	90000	525	1,37	161	0,84	58	0,53	30	0,39
3955,28	46000	69000	92000	546	1,40	167	0,85	59	0,55	31	0,40
4041,27	47000	70500	94000	568	1,43	173	0,87	63	0,56	33	0,41
4127,25	48000	72000	96000	590	1,46	180	0,89	64	0,57	34	0,41
4213,24	49000	73500	98000	612	1,49	187	0,91	66	0,58	35	0,42
4299,22	50000	75000	100000	634	1,52	194	0,93	69	0,59	36	0,43
4406,70	51250	76875	102500	663	1,55	203	0,95	74	0,61	38	0,44
4514,18	52500	78750	105000	693	1,59	212	0,97	78	0,63	40	0,45
4621,66	53750	80625	107500	722	1,63	221	0,99	80	0,65	41	0,46
4729,14	55000	82500	110000	752	1,67	230	1,02	84	0,66	43	0,47
4836,62	56250	84375	112500	784	1,71	239	1,04	86	0,67	45	0,48
4944,11	57500	86250	115000	816	1,75	248	1,06	90	0,69	47	0,50
5051,59	58750	88125	117500	848	1,79	258	1,09	93	0,70	48	0,51
5159,07	60000	90000	120000	880	1,83	268	1,12	96	0,72	50	0,52
5374,03	62500	93750	125000	948	1,90	289	1,16	100	0,75	54	0,54
5588,99	65000	97500	130000	1016	1,98	310	1,21	112	0,78	58	0,56

Table 19: Mass flow, heat performance and pressure loss for Wavin Tigris multilayer Pipes.

Mass flow kg/h	Heatperformance W			Pipe dimensions mm							
				40 x 4,0 d _i = 32		50 x 4,5 d _i = 41		63 x 6,0 d _i = 51		75 x 7,5 d _i = 60	
	with a delta of (K)			Pressure loss R (Pa/m) + Velocity v (m/s)							
				10	15	20	R	v	R	v	R
5803,95	67500	101250	135000			332	1,25	119	0,80	62	0,58
6018,91	70000	105000	140000			354	1,30	125	0,82	66	0,60
6448,83	75000	112500	150000			400	1,39	145	0,90	74	0,65
6878,76	80000	120000	160000			449	1,48	161	0,94	83	0,69
7308,68	85000	127500	170000			501	1,58	182	1,02	93	0,73
7738,60	90000	135000	180000			555	1,67	198	1,08	103	0,78
8168,52	95000	142500	190000			610	1,76	218	1,12	113	0,82
8598,45	100000	150000	200000			671	1,85	242	1,20	124	0,86
9028,37	105000	157500	210000			733	1,95	260	1,23	135	0,91
9458,29	110000	165000	220000			797	2,04	288	1,40	147	0,95
9888,22	115000	172500	230000					309	1,37	159	0,99
10318,14	120000	180000	240000					336	1,40	172	1,03
10748,06	125000	187500	250000					361	1,49	185	1,08
11177,99	130000	195000	260000							198	1,12
11607,91	135000	202500	270000							212	1,16
12037,83	140000	210000	280000							226	1,21
12467,76	145000	217500	290000							241	1,25
12897,68	150000	225000	300000							256	1,29
13327,60	155000	232500	310000							271	1,34
13757,52	160000	240000	320000							287	1,38
14187,45	165000	247500	330000							304	1,42

Table 19: Mass flow, heat performance and pressure loss for Wavin Tigris multilayer Pipes.

4.3. Pressing Tools

In this chapter all details can be found on the tools that should be used for Wavin Tigris applications. Use the proper tools to ensure a Wavin System warranty.

4.3.1 Wavin pressing jaws and alternative brand pressing profiles

External certification in accordance with DIN EN ISO 21003-3 and 5:2008-11 is carried out exclusively on the basis of press joints created using Wavin Tigris fittings and pipes and Wavin press tools and jaws with the approved profiles.

The following pressing profiles are released for Wavin Tigris with system warranty:

- ⦿ Tigris K5, Tigris M5 allow the following pressing profiles: U, Up, TH, H, B

They cover the diameter ranges
14, 16, 20, 25, 26, 32, 40 mm*)

- ⦿ Tigris K1 and Tigris M 1 allow the following pressing profile: U and Up

They cover the diameter ranges
50, 63, 75 mm

*) The Tigris K1 and Tigris M1 in the range 14-40 mm that have been replaced by Tigris K5, Tigris M5 only allowed U and Up profile

If a different press tool is used, it must meet the minimum requirements listed below (e.g. linear thrust of 30 – 34 kN, use a suitable pressing jaw fixture etc) and must be technically flawless. This means it must be serviced and maintained according to the manufacturer's specifications.

For the purpose of liability and security, we recommend contacting the respective manufacturer for proof of suitability. In the event that a complaint is made and the damage can be traced back to an unsuitable press tool from a different manufacturer, Wavin shall carry no responsibility or liability.

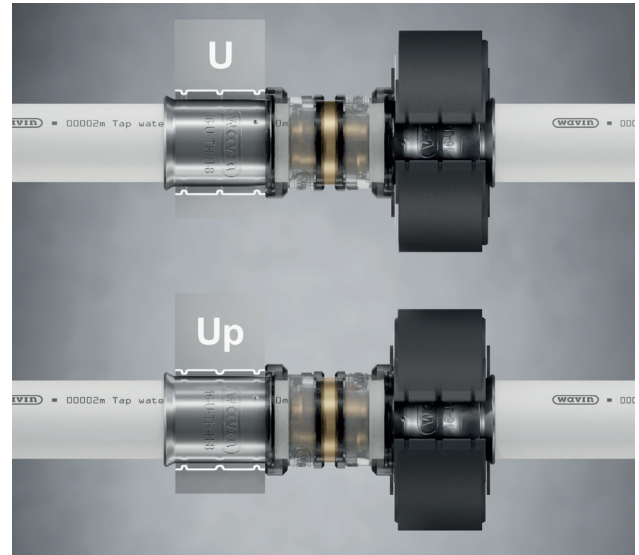

Fig. 51: Released pressing profiles for Tigris K1/K5, Tigris M1/M5.

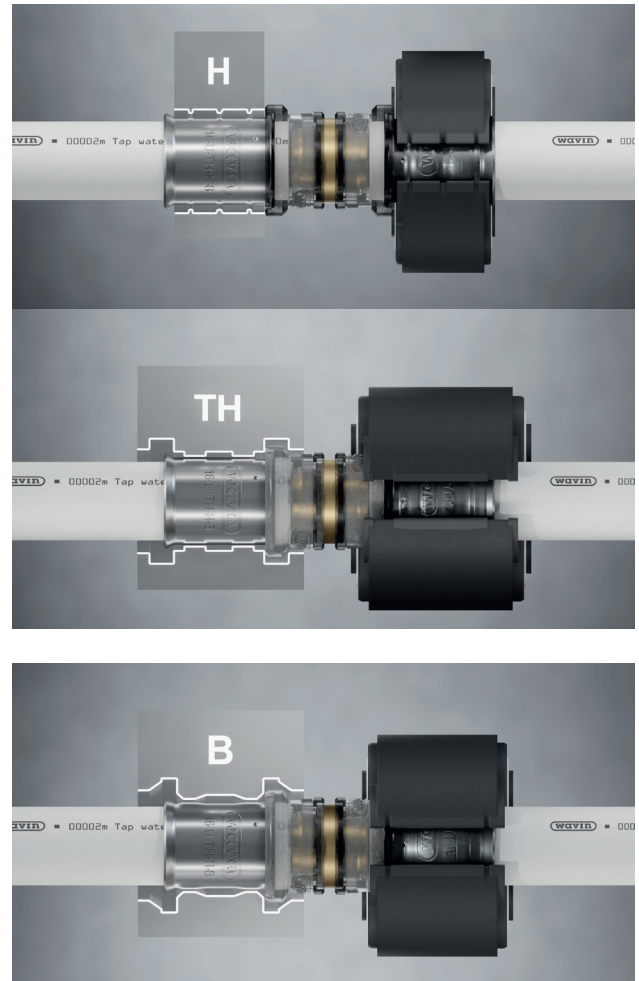

Fig. 52: Released pressing profiles for Tigris K5, Tigris M5.

The press tools must meet the following requirements:

- ⌚ The press tool must be operated and serviced according to the respective manufacturer guidelines. The Wavin assembly guidelines must be complied with.
- ⌚ The “mini” press (14 - 32 mm) must provide a linear thrust of at least 15kN, for 16 - 32 mm and of 19kN for 40 mm.
- ⌚ The “cordless” press (16 -75 mm) must provide a linear thrust of 30kN to 34kN.
- ⌚ The bolt geometry of the press tool must be suitable for the Wavin pressing jaws.

Important note:

The following press tools from Rems/Roller must not be used with the Wavin pressing jaws:

- ⌚ REMS Power-Press E REMS Power-Press 2000
- ⌚ ROLLER Uni-Press E ROLLER Uni-Press 2000

To check the compatibility of Wavin Tigris K1/M1 pressing jaws with alternative brand press tools, please see chapter 4.3.4

4.3.2. Cordless and electric press tools

Wavin press-tools are supplied to the highest quality and manufacturing standards. Under correct operation and when all the necessary device inspections are carried out at regular intervals, the press tool warranty runs for 24 months from the despatch date or for 10,000 pressing operations whichever is sooner. Please refer to the respective press tool operating instructions for further details on operation and maintenance. The warranty is activated from the day of despatch from Wavin.

The warranty does not cover any damage caused by improper handling or failure to observe the operating instructions or use with pipes or fittings not supplied by Wavin. Warranty services may be provided by the manufacturer only. Claims shall only be accepted if the device is supplied to the manufacturer fully intact, fully documented and with no interventions.



Fig. 53: Wavin pressing tool and pressing jaws.

Inspection and service

The reliable performance of the press tool is dependent on careful handling. This is an important requirement for the tool to ensure long-lasting joints. The device requires regular service and maintenance. For any fault or fault message check in the manual included with the tool.

Only a clean and operational press tool can ensure a long-lasting sealed joint. The pressing jaws must only be used for their intended purpose of pressing Wavin Tigris fittings and should only be replaced by a qualified technicians.

Wavin tools

Novopress	Klauke
ACO 102	UAP2
ACO 202	UAP3L MAP1
ECO 202	MAP2L UP2EL-14
ACO 203	UNP 2
ECO 203	
and the respective U-profile pressing jaws	and the respective U-profile pressing jaws

Caution:

Do not open the device! If any seals are damaged the warranty shall be void. An annual inspection is required. A major service is required every 10,000 pressing operations or every three years, whichever is sooner.

4.3.3. Overview of compatible press tools

The table below illustrates Wavin Tigris K5& K1/ M5 & M1 pressing jaw compatibility with alternative brand press tools. This table lists only “compatible devices” with a pressing force of 32 kN (± 2 kN) and 40 mm piston stroke. The “mini” versions are not listed here since they are generally not compatible. If using press tools and pressing jaws not listed here, proof of suitability for the Wavin Tigris K5 & K1/M1 systems must be provided in accordance with the corresponding national regulations.

According to technical specifications, the Wavin Tigris K1/K5/M1/M5 system can be used with the following device types.

Machine type/description	Features	Pressing jaw dimension
Wavin	UAP3L	16 to 63 mm
Wavin	ACO202	16 to 63 mm
Wavin	ECO202	16 to 63 mm
Uponor electric press tool	UP 50 EL	16 to 63 mm
Uponor cordless press tool	UP 75	16 to 63 mm
Uponor electric press tool	UP 75 EL	16 to 63 mm
Geberit “new” PWH-75	Blue sleeve above pressing jaw fixture	16 to 63 mm
Novopress EFP 2 (manuf. after 1996)	Swivel head	16 to 63 mm
Novopress ACO 1/ECO 1 (Pressboy)	ACO 1 = cordless ECO 1 = electric	16 to 63 mm
Novopress ACO201/ECO201	ACO201 = cordless ECO201 = electric	16 to 63 mm
Novopress AFP201/EFP201	AFP201 = cordless EFP201 = electric	16 to 63 mm
Novopress AFP202/EFP202	AFP202 = cordless EFP202 = electric	16 to 63 mm
Klauke ipress	UAP3L	16 to 63 mm
Milwaukee	M18 HPT	16 to 63 mm
REMS Power-Press		16 to 63 mm
REMS Power-Press ACC		16 to 63 mm
REMS Akku-Press		16 to 63 mm
REMS Akku-Press ACC		16 to 63 mm
ROLLER'S Uni-Press		16 to 63 mm
ROLLER'S Uni-Press ACC		16 to 63 mm
ROLLER'S Multi-Press		16 to 63 mm
ROLLER'S Multi-Press ACC		16 to 63 mm
Rothenberger ROMAX® 3000		16 to 63 mm
Ridgid cordless press tool	RP 340-B	16 to 63 mm
Ridgid electric press tool	RP 340-C	16 to 63 mm
Viega cordless press tool	Pressgun 5	16 to 63 mm
Viega cordless press tool	Pressgun 4B	16 to 63 mm
Viega electric press tool	Pressgun 4E	16 to 63 mm
Viega electric	Type PT3-EH/H	16 to 63 mm
Viega electric press tool	Type 2 (manuf. after 1996) Serial numbers starting with 96...; lateral leverage for bolt monitoring	16 to 63 mm

Damage report / check list

Customer: _____

Street: _____

City / Postcode / Country: _____

Telephone / Fax: _____

E-mail: _____

Contact person: _____

Responsible Wavin Overseas distributor or Agent (supplier): _____

Please find enclosed:

UAP2 cordless press tool	<input type="checkbox"/>	delivered with:	case	<input type="checkbox"/>
UAP3L cordless press tool	<input type="checkbox"/>		battery	<input type="checkbox"/>
„Mini“ MAP 1 cordless press tool	<input type="checkbox"/>		charging unit	<input type="checkbox"/>
„Mini“ MAP 2L cordless press tool	<input type="checkbox"/>			
UP2EL-14 electric press tool	<input type="checkbox"/>			
UNP 2 electric press tool	<input type="checkbox"/>			
ACO202 cordless press tool	<input type="checkbox"/>			
"Mini" ACO102 cordless press tool	<input type="checkbox"/>			
ECO202 electric press tool	<input type="checkbox"/>			

Other tools: _____ Pressing jaw _____
(please indicate number and dimension) _____

Tool number: _____

The tool has been sent for: Repair Service Inspection

In the event of repair, please specify the reason:

- Tool is losing oil
- Faulty piston
- Press procedure not correctly ended
- Tool does not generate pressure
- Housing broken
- Faulty motor
- Pressing jaw mount cracked
- Faulty switch
- Battery does not work
- Charging unit does not work

Other complaints:

Price quotation requested? Yes No

Date, Location

Signature

5. Use of chemicals

5.1. Disinfection of drinking water pipelines

The Wavin multilayer composite pipes are designed for use in the drinking water installation and certified accordingly, so that they can be used without any problems and a hygienically flawless installation can be established.

Disinfection measures are therefore normally not necessary. If, however, there is a compelling necessity due to a case of contamination, this is to be considered as an immediate emergency measure to return the installation to a serviceable condition.

The actual cause of the contamination (faulty operation, structural defects) must be rectified. Frequently recurring disinfections to maintain the serviceability of the installation must be avoided and do not correspond to the state of the art. If these are necessary, rehabilitation is to be preferred to installation. Frequent disinfections have a negative influence on the service life of an installation.

5.2. Thermal Disinfection

Usually conditions and parameters for thermal disinfection of drinking water systems foresee that “each tapping point must be exposed to at least 70 °C for at least 3 minutes when the outlet is open. Therefore, the water in the DHW heater must be heated above 70 °C. Temperature and duration are to be observed at all times. The outlet temperature must be “checked” at each tapping point.” (According DVGW Worksheet W551).

Disinfection of the Wavin Tigris multi-layer composite pipes is possible using the method described. Classification of operating conditions according to ISO 10508 must be observed.

The Wavin installation pipe systems are designed for drinking water installations according to application class 2 and for heating installations suitable according to application class 5. See below table

Classification of service conditions ISO 21003-1:2008

Class	Design temp.	Years T_D	Years T_{max}	T_{mal}	Hours T_{mal}	Application
1	60 °C	49	1	95 °C	100	Hot water 60 °C
2	70 °C	49	1	95 °C	100	Hot water 70 °C
4	20-40-60 °C*	2,5-20-25*	2,5	100 °C	100	Low temperature heating
5	20-60-80 °C*	14-25-10*	1	100 °C	100	High temperature heating

T_D = design temperature

T_{max} = maximum temperature

T_{mal} = malfunction temperature

Table 22: Classification of service conditions- ISO 21003-1:2008 (E).

5.3. Chemical Disinfection

In general, the Wavin Tigris pipe can be disinfected chemically but certain aspects shall be taken into consideration. Especially long duration applications could have an impact on the life-time applications have impact on the life-time expectations of the system. For further information please contact your technical advisor at Wavin.

By following the rules of DVGW Code of Practice W 291 the implementation of chemical disinfection measures is regulated. The parameters described there such as active substances, concentrations, maximum temperatures and duration of application must be observed. The Wavin Tigris multi-layer composite pipe can be disinfected with the disinfectants described in the worksheet, but the dosages of the chemicals must not be exceeded.

5.4. List of allowed chemicals

The following chemicals have been tested and have been released for operation with the Tigris MP systems.

Products	MP pipe	Tigris M1 / M5	Tigris K1 / K5	smartFIX
Ethylene glycol < 35%	✓	✓	✓	✓
Teflon / PTFE tape	✓	✓	✓	✓
Hemp + Fermit	✓	✓	✓	✓
Loctite 55	✓	✓	✗	✗
Paints, sprays, (2-part) adhesives [as e.g. Armaflex 520]	✓	✓	✗	✗
Cold welding agents contain Acetone or Tetrahydrofuran (THF)	✓	✓	✗	✗
Air pressurized system, based on oil free systems according to ISO 8573-1, class 1	✓	✓	✓	✓
Returned Osmosis water	✓	✗	✓	✓

Application of solvents containing stress corrosion cracking media, like ammonium- chloride and nitrate must be avoided.

Chemical Shock disinfection

Disinfectant	Max. concentration	Max. temperature	Max. time	Max. number of cycles
Chlordioxid ClO ₂	6 ppm as ClO ₂	< 23 C	12 h	5
Hypochlorite Cl ₂	50 ppm as Cl ₂	< 23° C	12 h	5
Hydrogen peroxide H ₂ O ₂	150 ppm	< 23° C	12 h	5
Potassium Permanganate KMnO ₄	12 ppm	< 23° C	12 h	5

Above overview is just a short list. Please contact your local sales representative In case of doubts.

Table 23: Overview of allowed chemicals.

6. Certifications

Wavin Tigris systems holds the following certifications:

Approval/ Quality Mark	Country
VA + GDV	Denmark
ATG	Belgium
NF	France
IIP-UNI	Italy
WRAS	United Kingdom
KOMO / KIWA	Netherlands
B-Mark	Poland
STF	Finland
DVGW	Germany
RISE	Sweden
SINTEF	Norway

7. Local Regulations

What is necessary but not covered by this “general” version:

E.g. Checklist Germany:

Required information in the installation and installation instructions

1. Material selection according to the data for water analysis DIN 1988-7
2. Type of pipe connection
3. Suitable thread sealants
4. Pipe fixation
5. Length changes / expansion compensation
6. Contact with other building materials / protection pipes
7. Wall and ceiling ducts
8. Sound insulation
9. Fire protection according to specifications
10. Type of position stabilization (clamp spacing, supports, etc.)
11. Pressure test and flushing of pipes according to DIN 1988
12. Resistance to internal and external corrosion
13. Mixed installation with other materials
14. Suitable materials for thermal insulation

8. Product portfolio

8.1. Product portfolio M5 & M1

Tigris M5



Tigris M5

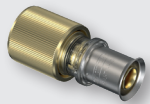

Connector
toilet



Elbow
toilet

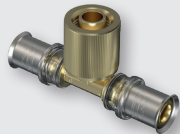

Tee
toilet

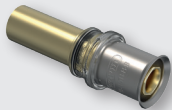

Coupler
metal



Elbow
metal

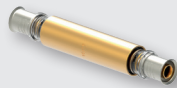

Repair
coupler



Radiator
wall



Radiator
floor



Elbow
radiator



Tee
radiator



Cross
fitting

8.2. Product portfolio K5 & K1

Tigris K5



8.3. Product portfolio on SKU level

Local portfolio on SKU level.

Notes

Discover our broad portfolio at wavin.com

Water management
Heating and cooling

Water and gas distribution
Waste water drainage



Wavin is part of Orbia, a community of companies working together to tackle some of the world's most complex challenges. We are bound by a common purpose: To Advance Life Around the World.



Wavin B.V. P.O. Box 173 | 8000 AD Zwolle | The Netherlands | Phone +31 (0)38 - 429 49 11
Internet www.wavin.com | E-mail info@wavin.com

Wavin operates a programme of continuous product development, and therefore reserves the right to modify or amend the specification of their products without notice. All information in this publication is given in good faith, and believed to be correct at the time of going to press. However, no responsibility can be accepted for any errors, omissions or incorrect assumptions.

© 2019 Wavin Wavin reserves the right to make alterations without prior notice. Due to continuous product development, changes in technical specifications may change. Installation must comply with the installation instructions. All rights reserved. No part of this book may be reproduced, reprinted or utilized in any form or by any means, whether electronic, mechanical, by photocopies, recordings, or other means, now known or hereafter invented, without prior written permission from the publisher.