



Drainage Systems

TECEdrainpoint S POINT DRAINS

ASSORTMENT LIST 2019

	Page
Drain sets	232
Drains	236
Drain tops	240
Grates	245
Accessories	247
Spare parts	251
Drainage capacity values	253

An overview of valid Declaration of Performance (DOP) is available on our website www.tece.com.

TECEdrainpoint S – Drain sets

TECEdrainpoint S 50 drain set extra-flat

Drain set TECEdrainpoint S 50 horizontal, extra-flat DN 50.

Consisting of:

- Drain body DN 50 horizontal, extra-flat, made of plastic (PP)
- Retaining edge
- With removable odour trap
- Reduced sealing water height = 30 mm
- Drain top with grate frame made of plastic (ABS) and o-ring seal
- TECEdrainpoint S design grate made of drawn stainless steel, material 1.4301 (304), dimensions 100 x 100 mm, polished surface, load class K3 (load bearing capacity up to 300 kg)

Drainage capacity to DIN EN 1253 at 10/20 mm water level over grate:

- With minimum height of the drain top: 0.52/0.61 l/s
- With maximum height of the drain top: 0.69/1.12 l/s

Delivery incl. protective cap, foil for the construction site and assembly instructions.

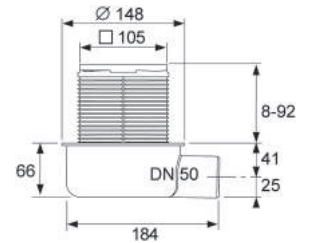

Order No.	DU 1	DU 2
3601050	1 pc.	10 pc.

TECEdrainpoint S 110 drain set extra-flat with Seal System universal flange*

Floor drain set TECEdrainpoint S 110 horizontal, extra-flat DN 50.

Consisting of:

- Drain body DN 50 horizontal, extra-flat, made of plastic (PP)
- With universal flange for connection of composite seals in accordance with DIN 18534 or clamped flange connections
- With integrated ball joint
- With lateral inflow DN 40 incl. closure plug
- With removable odour trap
- Discharge capacity from 0.62 to 0.98 l/s
- Reduced sealing water height = 30 mm
- Drain top with grate frame made of plastic (ABS) and O-ring seal
- TECEdrainpoint S design grate made of drawn stainless steel, material 1.4301 (304), dimensions 100 x 100 mm, polished surface, load class K3 (load up to 300 kg)

Drainage capacity to DIN EN 1253 at 10/20 mm water level over grate:

- With minimum height of the drain top: 0.52/0.61 l/s
- With maximum height of the drain top: 0.69/1.12 l/s

Delivery incl. protective cap, protective foil for on-site protection during construction, and assembly instructions.

Please order separately – depending on seal type:

- Seal System sealing sleeve for the execution of an independently tested connection to the composite seal
- Compression ring set and cut-to-size sealing foil for clamped flange connections

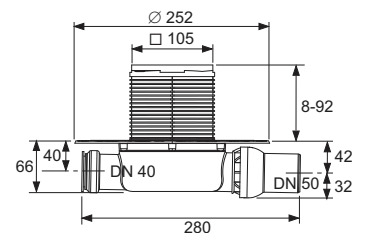

Order No.	DU 1	DU 2
3601100	1 pc.	10 pc.

TECEdrainpoint S 112 drain set extra-flat with Seal System universal flange and stainless steel grate frame*

Floor drain set TECEdrainpoint S 112 horizontal, extra-flat DN 50, stainless steel grate frame with stainless steel grate and two-stage membrane odour trap.

- Drain body DN 50 horizontal, extra-flat, made of plastic (PP)
- With universal flange for connection of composite seals in accordance with DIN 18534 or clamped flange connections
- With integrated ball joint
- With lateral inflow DN 40 incl. closure plug
- With removable 2-stage membrane odour trap
- 20 mm sealing water and additional sealing lip membrane
- Drain top with grate frame made of plastic (ABS) and O-ring seal
- Grate frame made of drawn stainless steel, material 1.4301 (304), for grate dimensions 100 x 100 mm
- TECEdrainpoint S design grate made of drawn stainless steel, material 1.4301 (304), dimensions 100 x 100 mm, polished surface, load class K3 (load up to 300 kg)

Drainage capacity to DIN EN 1253 at 10/20 mm water level over grate:

- With minimum height of the drain top: 0.51/0.61 l/s
- With maximum height of the drain top: 0.56/1.23 l/s

Delivery incl. protective cap, protective foil for on-site protection during construction, and assembly instructions.

Please order separately – depending on seal type:

- Seal System sealing sleeve for the execution of an independently tested connection to the composite seal
- Compression ring set and cut-to-size sealing foil for clamped flange connections

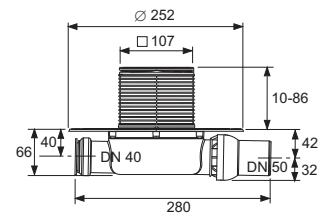

Order No.	DU 1	DU 2
3601102	1 pc.	10 pc.

TECEdrainpoint S – Drain sets

TECEdrainpoint S 120 drain set standard with Seal System universal flange*

Floor drain set TECEdrainpoint S 120 horizontal, standard DN 50, tested to DIN EN 1253.

Consisting of:

- Drain body DN 50 horizontal, extra-flat, made of plastic (PP)
- With universal flange for connection of composite seals in accordance with DIN 18534 or clamped flange connections
- With integrated ball joint
- With lateral inflow DN 40 incl. closure plug
- With removable odour trap
- Sealing water height = 50 mm to DIN EN 1253
- Drain top with grate frame made of plastic (ABS) and O-ring seal
- TECEdrainpoint S design grate made of drawn stainless steel, material 1.4301 (304), dimensions 100 x 100 mm, polished surface, load class K3 (load up to 300 kg)

Drainage capacity to DIN EN 1253 at 10/20 mm water level over grate:

- With minimum height of the drain top: 0.52/0.89 l/s
- With maximum height of the drain top: 0.64/1.35 l/s

Delivery incl. protective cap, protective foil for on-site protection during construction, and assembly instructions.

Please order separately – depending on seal type:

- Seal System sealing sleeve for the execution of an independently tested connection to the composite seal
- Compression ring set and cut-to-size sealing foil for clamped flange connections

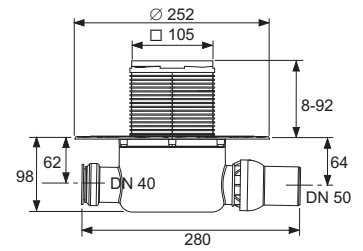

Order No.	DU 1	DU 2
3601200	1 pc.	10 pc.

TECEdrainpoint S 122 drain set standard with Seal System universal flange and stainless steel grate frame*

Floor drain set TECEdrainpoint S 122 horizontal, DN 50, stainless steel grate frame with stainless steel grate and 2-stage membrane odour trap.

- Drain body DN 50 horizontal, made of plastic (PP)
- With universal flange for connection of composite seals in accordance with DIN 18534 or clamped flange connections
- With integrated ball joint
- With lateral inflow DN 40 incl. closure plug
- With removable 2-stage membrane odour trap
- 50 mm sealing water and additional sealing lip membrane
- Drain top with grate frame made of plastic (ABS) and O-ring seal
- Grate frame made of drawn stainless steel, material 1.4301 (304), for grate dimensions 100 x 100 mm
- TECEdrainpoint S design grate made of drawn stainless steel, material 1.4301 (304), dimensions 100 x 100 mm, polished surface, load class K3 (load up to 300 kg)

Drainage capacity to DIN EN 1253 at 10/20 mm water level over grate:

- With minimum height of the drain top: 0.54/0.85 l/s
- With maximum height of the drain top: 0.71/1.35 l/s

Delivery incl. protective cap, protective foil for on-site protection during construction, and assembly instructions.

Please order separately – depending on seal type:

- Seal System sealing sleeve for the execution of an independently tested connection to the composite seal
- Compression ring set and cut-to-size sealing foil for clamped flange connections

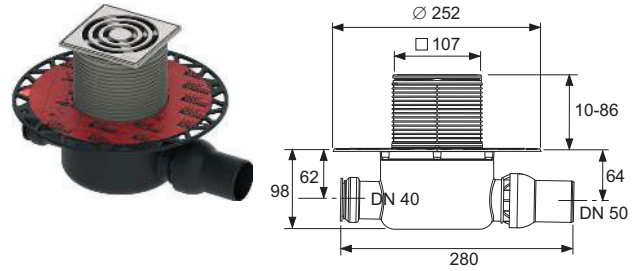

Order No.	DU 1	DU 2
3601202	1 pc.	10 pc.

TECEdrainpoint S 130 drain set vertical with Seal System universal flange*

Floor drain set TECEdrainpoint S 130 vertical DN 50, tested to DIN EN 1253.

Consisting of:

- Drain DN 50 vertical, made of plastic (PP)
- With universal flange for connection of composite seals in accordance with DIN 18534 or clamped flange connections
- With removable odour trap
- Sealing water height = 50 mm to DIN EN 1253
- Drain top with grate frame made of plastic (ABS) and O-ring seal
- TECEdrainpoint S design grate made of drawn stainless steel, material 1.4301 (304), dimensions 100 x 100 mm, polished surface, load class K3 (load up to 300 kg)

Drainage capacity to DIN EN 1253 at 10/20 mm water level over grate:

- With minimum height of the drain top: 0.64/1.36 l/s
- With maximum height of the drain top: 0.70/1.56 l/s

Delivery incl. protective cap, protective foil for on-site protection during construction, and assembly instructions.

Please order separately – depending on seal type:

- Seal System sealing sleeve for the execution of an independently tested connection to the composite seal
- Compression ring set and cut-to-size sealing foil for clamped flange connections

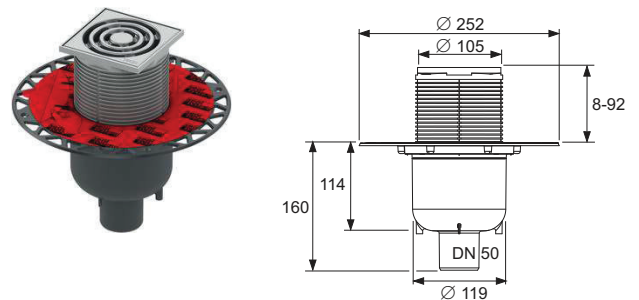

Order No.	DU 1	DU 2
3601300	1 pc.	10 pc.

TECEdrainpoint S – Drains

TECEdrainpoint S drain DN 50 extra-flat with Seal System universal flange*

TECEdrainpoint S DN 50 floor drain, horizontal, extra-flat, made of plastic (PP).

- With universal flange for connection of composite seals in accordance with DIN 18534 or clamped flange connections
- With ball joint
- With lateral inflow DN 40 including closure plug
- With removable odour trap
- Reduced sealing water height = 30 mm

Drainage capacity to DIN EN 1253 at 10/20 mm water level over grate:

- With minimum height of the drain top: 0.52/0.61 l/s
- With maximum height of the drain top: 0.69/1.12 l/s

Delivery includes protective cap, protective foil for on-site protection during construction and assembly instructions.

Please order separately – depending on seal type:

- Seal System sealing sleeve for the execution of an independently tested connection to the composite seal
- Compression ring set and cut-to-size sealing foil for clamped flange connections

Note:

Drainage capacity values measured with drain top and design grate 100 mm (Order No. 3660001), for further drain capacity values see the relevant chapter.

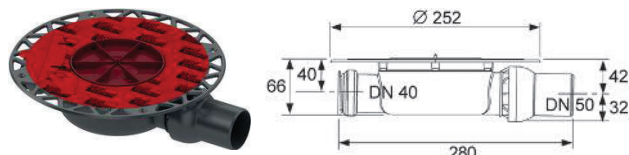

Order No.	DU 1
3601400	1 pc.

TECEdrainpoint S drain DN 50 terrace with Seal System universal flange*

Floor drain TECEdrainpoint S DN 50 as terrace or balcony drain, horizontal, extra-flat, made of plastic (PP).

- With universal flange for connection of composite seals in accordance with DIN 18534 or clamped flange connections
- Without odour trap

Drainage capacity to DIN EN 1253 at 10/20 mm water level over grate:

- With minimum height of the drain top: 0.66/1.22 l/s
- With maximum height of the drain top: 0.50/1.51 l/s

Delivery incl. protective cap, protective foil for on-site protection during construction, and assembly instructions.

Please order separately – depending on seal type:

- Seal System sealing sleeve for the execution of a tested and certified connection to the composite seal
- Compression ring set and cut-to-size sealing foil for clamped flange connections

Note:

Drainage capacity values measured with drain top and design grate 100 mm (Order No. 3660001), for further drain capacity values see the relevant chapter.

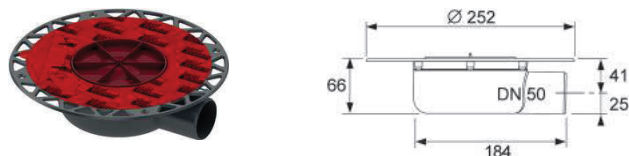

Order No.	DU 1
3601401	1 pc.

TECEdrainpoint S drain DN 50 standard with Seal System universal flange*

Floor drain TECEdrainpoint S DN 50 horizontal, standard, made of plastic (PP), tested to DIN EN 1253.

- With universal flange for connection of composite seals in accordance with DIN 18534 or clamped flange connections
- With lateral inflow DN 40 including closure plug
- With removable odour trap
- Sealing water height = 50 mm to DIN EN 1253

Drainage capacity to DIN EN 1253 at 10/20 mm water level over grate:

- With minimum height of the drain top: 0.52/0.89 l/s
- With maximum height of the drain top: 0.64/1.35 l/s

Delivery incl. protective cap, protective foil for on-site protection during construction, and assembly instructions.

Please order separately – depending on seal type:

- Seal System sealing sleeve for the execution of a tested and certified connection to the composite seal
- Compression ring set and cut-to-size sealing foil for clamped flange connections

Note:

Drainage capacity values measured with drain top and design grate 100 mm (Order No. 3660001), for further drain capacity values see the relevant chapter.

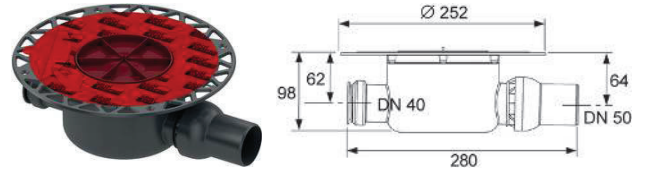

Order No.	DU 1
3601500	1 pc.

TECEdrainpoint S drain DN 50 vertical with Seal System universal flange*

Floor drain TECEdrainpoint S DN 50 vertical, standard, made of plastic (PP), tested to DIN EN 1253.

- With universal flange for connection of composite seals in accordance with DIN 18534 or clamped flange connections
- With removable odour trap
- Sealing water height = 50 mm to DIN EN 1253

Drainage capacity to DIN EN 1253 at 10/20 mm water level over grate:

- With minimum height of the drain top: 0.64/1.36 l/s
- With maximum height of the drain top: 0.70/1.56 l/s

Delivery incl. protective cap, protective foil for on-site protection during construction, and assembly instructions.

Please order separately – depending on seal type:

- Seal System sealing sleeve for the execution of a tested and certified connection to the composite seal
- Compression ring set and cut-to-size sealing foil for clamped flange connections

Note:

Drainage capacity values measured with drain top and design grate 100 mm (Order No. 3660001), for further drain capacity values see the relevant chapter.

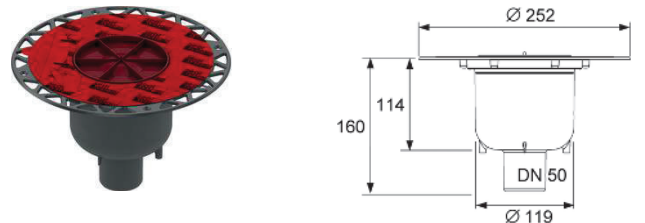

Order No.	DU 1
3601600	1 pc.

TECEdrainpoint S – Drains

TECEdrainpoint S drain DN 70 with Seal System universal flange*

Floor drain TECEdrainpoint S DN 70 vertical, standard, made of plastic (PP), tested to DIN EN 1253.

- With universal flange for connection of composite seals in accordance with DIN 18534 or clamped flange connections
- With lateral inflow DN 50 incl. closure plug
- With removable odour trap
- Sealing water height = 50 mm to DIN EN 1253

Drainage capacity to DIN EN 1253 at 10/20 mm water level over grate:

- With minimum height of the drain top: 0.62/1.22 l/s
- With maximum height of the drain top: 0.87/1.74 l/s

Delivery incl. protective cap, protective foil for on-site protection during construction, and assembly instructions.

Please order separately – depending on seal type:

- Seal System sealing sleeve for the execution of a tested and certified connection to the composite seal
- Compression ring set and cut-to-size sealing foil for clamped flange connections

Note:

Drainage capacity values measured with drain top and design grate 150 mm (Order No. 3660003), for further drain capacity values see the relevant chapter.

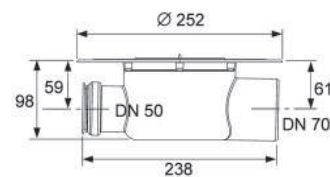

Order No.	DU 1
3603500	1 pc.

TECEdrainpoint S drain DN 70 vertical with Seal System universal flange*

Floor drain TECEdrainpoint S DN 70 vertical, standard, made of plastic (PP), tested to DIN EN 1253.

- With universal flange for connection of composite seals in accordance with DIN 18534 or clamped flange connections
- With removable odour trap
- Sealing water height = 50 mm to DIN EN 1253

Drainage capacity to DIN EN 1253 at 10/20 mm water level over grate:

- With minimum height of the drain top: 0.47/1.81 l/s
- With maximum height of the drain top: 0.63/1.84 l/s

Delivery incl. protective cap, protective foil for on-site protection during construction, and assembly instructions.

Please order separately – depending on seal type:

- Seal System sealing sleeve for the execution of a tested and certified connection to the composite seal
- Compression ring set and cut-to-size sealing foil for clamped flange connections

Note:

Drainage capacity values measured with drain top and design grate 150 mm (Order No. 3660003), for further drain capacity values see the relevant chapter.

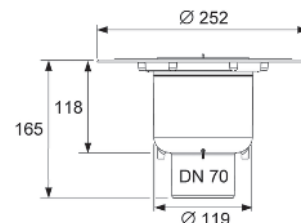

Order No.	DU 1
3603600	1 pc.

TECEdrainpoint S drain DN 100 with Seal System universal flange*

Floor drain TECEdrainpoint S DN 100 vertical, standard, made of plastic (PP), tested to DIN EN 1253

- With universal flange for connection of composite seals in accordance with DIN 18534 or clamped flange connections
- With lateral inflow DN 50 incl. closure plug
- With removable odour trap
- Sealing water height = 50 mm to DIN EN 1253

Drainage capacity to DIN EN 1253 at 10/20 mm water level over grate:

- With minimum height of the drain top: 0.90/1.61 l/s
- With maximum height of the drain top: 0.86/2.03 l/s

Delivery incl. protective cap, protective foil for on-site protection during construction, and assembly instructions.

Please order separately – depending on seal type:

- Seal System sealing sleeve for the execution of a tested and certified connection to the composite seal
- Compression ring set and cut-to-size sealing foil for clamped flange connections

Note:

Drainage capacity values measured with drain top and design grate 150 mm (Order No. 3660003), for further drain capacity values see the relevant chapter.

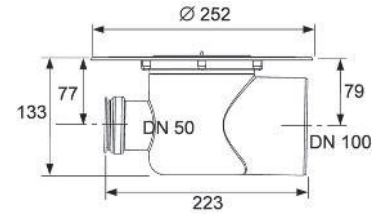

Order No.	DU 1
3607500	1 pc.

TECEdrainpoint S drain DN 100 vertical with Seal System universal flange*

Floor drain TECEdrainpoint S DN 100 vertical, standard, made of plastic (PP), tested to DIN EN 1253

- With universal flange for connection of composite seals in accordance with DIN 18534 or clamped flange connections
- With removable odour trap
- Sealing water height = 50 mm to DIN EN 1253

Drainage capacity to DIN EN 1253 at 10/20 mm water level over grate:

- With minimum height of the drain top: 0.76/1.42 l/s
- With maximum height of the drain top: 0.80/2.10 l/s

Delivery incl. protective cap, protective foil for on-site protection during construction, and assembly instructions.

Please order separately – depending on seal type:

- Seal System sealing sleeve for the execution of an independently tested connection to the composite seal
- Compression ring set and cut-to-size sealing foil for clamped flange connections

Note:

Drainage capacity values measured with drain top and design grate 150 mm (Order No. 3660003), for further drain capacity values see the relevant chapter.

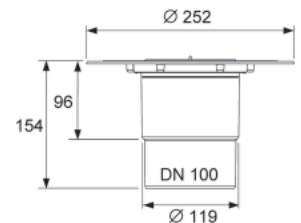

Order No.	DU 1
3607600	1 pc.

TECEdrainpoint S – Drain tops

TECEdrainpoint S grate frame stainless steel, 100 mm, frameless tile base

Set consisting of tileable drain top and tileable frameless base, 100 x 100 mm made of stainless steel.

- Outer diameter = 110 mm
- Height = 1 mm (suitable for all tile/natural stone thicknesses)
- Grate frame made of drawn stainless steel material 1.4301 (304)
- Frameless tile base made of stainless steel, material 1.4301 (304), dimensions 83 x 83 mm, polished surface, load class K3 (load up to 300 kg)

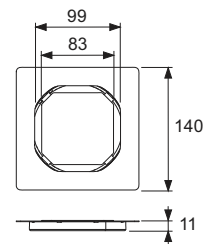

Order No.	DU 1
3660016	1 pc.

TECEdrainpoint S grate frame stainless steel, 150 mm, design "plate"

Set consisting of drain top with stainless steel grate frame and tileable channel "plate", 142 x 142 mm.

- Drain top made of plastic (ABS)
- O-ring seal
- Outer diameter = 110 mm
- Height adjustment = 23-118 mm
- Inner height of tileable insert = 10.5 mm
- Grate frame made of drawn stainless steel, material 1.4301 (304)
- Tileable channel plate made of stainless steel, material 1.4301 (304), dimensions 142 x 142 mm, polished surface, load class K3 (load up to 300 kg)

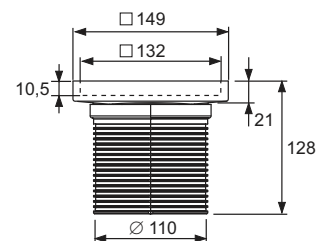

Order No.	DU 1
3660011	1 pc.

TECEdrainpoint S grate frame plastic, 100 mm, incl. design grate

Set consisting of drain top with grate frame (plastic) and TECEdrainpoint S design grate 100 x 100 mm.

- Drain top with grate frame made of plastic (ABS)
- O-ring seal
- Outer diameter = 110 mm
- Height adjustment = 10-92 mm
- TECEdrainpoint S design grate made of drawn stainless steel, material 1.4301 (304), dimensions 100 x 100 mm, polished surface, load class K3 (load up to 300 kg)

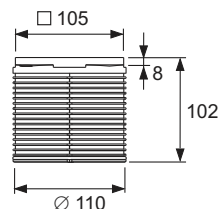

Order No.	DU 1
3660001	1 pc.

TECEdrainpoint S grate frame stainless steel, 100 mm, incl. design grate

Set consisting of drain top with grate frame (stainless steel) and TECEdrainpoint S design grate 100 x 100 mm.

- Drain top made of plastic (ABS)
- O-ring seal
- Outer diameter = 110 mm
- Height adjustment = 10-86 mm
- Grate frame made of drawn stainless steel, material 1.4301 (304)
- TECEdrainpoint S design grate made of drawn stainless steel, material 1.4301 (304), dimensions 100 x 100 mm, polished surface, load class K3 (load up to 300 kg)

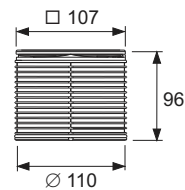

Order No.	DU 1
3660002	1 pc.

TECEdrainpoint S grate frame stainless steel, 100 mm, incl. design grate, screw-down

Set consisting of drain top with grate frame (stainless steel) and TECEdrainpoint S design grate 100 x 100 mm.

- Drain top made of plastic (ABS)
- O-ring seal
- Outer diameter = 110 mm
- Height adjustment = 10-86 mm
- Grate frame made of drawn stainless steel, material 1.4301 (304)
- TECEdrainpoint S design grate made of drawn stainless steel, material 1.4301 (304), dimensions 100 x 100 mm, polished surface, load class K3 (load up to 300 kg)
- Two stainless steel countersunk screws

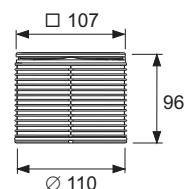

Order No.	DU 1
3660009	1 pc.

TECEdrainpoint S grate frame plastic, 150 mm, incl. design grate

Set consisting of drain top with grate frame (plastic) and TECEdrainpoint S design grate 142 x 142 mm.

- Drain top with grate frame made of plastic (ABS)
- O-ring seal
- Outer diameter = 110 mm
- Height adjustment = 12-92 mm
- TECEdrainpoint S design grate made of drawn stainless steel, material 1.4301 (304), dimensions 142 x 142 mm, polished surface, load class K3 (load up to 300 kg)

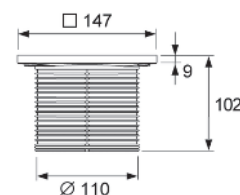

Order No.	DU 1
3660003	1 pc.

TECEdrainpoint S – Drain tops

TECEdrainpoint S grate frame stainless steel, 150 mm, incl. design grate

Set consisting of drain top with grate frame (stainless steel) and TECEdrainpoint S design grate 142 x 142 mm.

- Drain top made of plastic (ABS)
- O-ring seal
- Outer diameter = 110 mm
- Height adjustment = 12-88 mm
- Grate frame made of drawn stainless steel, material 1.4301 (304)
- TECEdrainpoint S design grate made of drawn stainless steel, material 1.4301 (304), dimensions 142 x 142 mm, polished surface, load class K3 (load up to 300 kg)

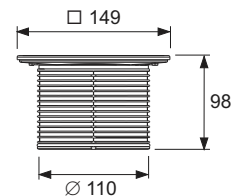

Order No.	DU 1
3660004	1 pc.

TECEdrainpoint S grate frame stainless steel, 150 mm, incl. design grate, screw-down

Set consisting of drain top with grate frame (stainless steel) and TECEdrainpoint S design grate 142 x 142 mm.

- Drain top made of plastic (ABS)
- O-ring seal
- Outer diameter = 110 mm
- Height adjustment = 12-88 mm
- Grate frame made of drawn stainless steel, material 1.4301 (304)
- TECEdrainpoint S design grate made of drawn stainless steel, material 1.4301 (304), dimensions 142 x 142 mm, polished surface, load class K3 (load up to 300 kg)
- Two stainless steel countersunk screws

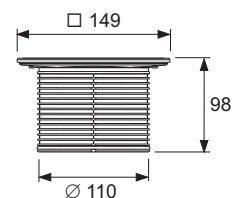

Order No.	DU 1
3660010	1 pc.

TECEdrainpoint S grate frame stainless steel, 100 mm, incl. design grate "quadratum"

Set consisting of drain top with stainless steel grate frame and design grate "quadratum" 100 x 100 mm.

- Drain top made of plastic (ABS)
- O-ring seal
- Outer diameter = 110 mm
- Height adjustment = 10-86 mm
- Grate frame made of drawn stainless steel, material 1.4301 (304)
- Design grate "quadratum" made of stainless steel, material 1.4301 (304), dimensions 100 x 100 mm, polished surface, load class L15 (load up to 1500 kg)

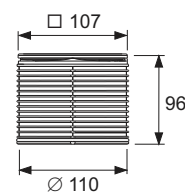

Order No.	DU 1
3660007	1 pc.

TECEdrainpoint S grate frame stainless steel, 150 mm, incl. design grate "quadratum"

Set consisting of drain top with stainless steel grate frame and design grate "quadratum" 142 x 142 mm.

- Drain top made of plastic (ABS)
- O-ring seal
- Outer diameter = 110 mm
- Height adjustment = 12-88 mm
- Grate frame made of drawn stainless steel, material 1.4301 (304)
- Design grate "quadratum" made of stainless steel, material 1.4301 (304), dimensions 142 x 142 mm, polished surface, load class L15 (load up to 1500 kg)

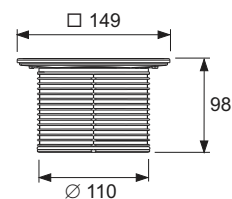

Order No.	DU 1
3660008	1 pc.

TECEdrainpoint S raising element with Seal System universal flange*

Drain top made of plastic with universal flange made of plastic (PP) for composite or clamped flange seals.

- With universal flange to connect composite seals or clamped flange connections
- Incl. O-ring seal
- Outer diameter = 110 mm
- Height adjustment = 12-95 mm

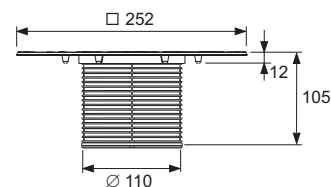
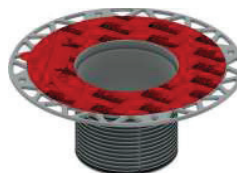

Order No.	DU 1
3660005	1 pc.



TECEdrainpoint S extension

Drain top extension made of plastic (ABS).

- With O-ring seal
- Outer diameter = 110 mm
- Height adjustment = 14-95 mm

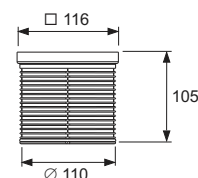

Order No.	DU 1
3660006	1 pc.

TECEdrainpoint S grate frame plastic, 100 mm, without grate

Consisting of drain top with grate frame (plastic) without grate.

- Drain top with grate frame made of plastic (ABS)
- O-ring seal
- Outer diameter = 110 mm
- Height adjustment range = 10-92 mm

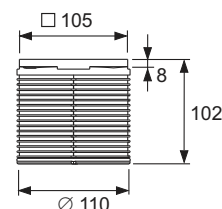

Order No.	DU 1
3660018	1 pc.

TECEdrainpoint S – Drain tops

TECEdrainpoint S grate frame plastic, 150 mm, without grate

Drain top with grate frame (plastic) without grate.

- Drain top made of plastic (ABS)
- O-ring seal
- Outer diameter = 110 mm
- Height adjustment range = 10-92 mm

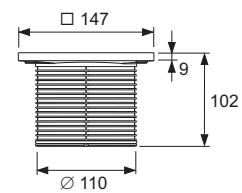

Order No.

3660019

DU 1

1 pc.

TECEdrainpoint S design grate stainless steel, 100 mm, screw-down

Design grate TECEdrainpoint S 100 x 100 mm made of drawn stainless steel, material 1.4301 (304), screw-down.

- Dimensions = 100 x 100 mm (outer dimensions)
- Polished surface
- Load class K3 (load up to 300 kg)
- Incl. two stainless steel countersunk screws and self-cutting threaded bushes

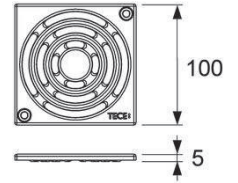

Order No.	DU 1
3665000	1 pc.

TECEdrainpoint S design grate stainless steel, 150 mm, screw-down

Design grate TECEdrainpoint S 142 x 142 mm made of drawn stainless steel, material 1.4301 (304), screw-down.

- Dimensions = 142 x 142 mm (outer dimensions)
- Polished surface
- Load class K3 (load up to 300 kg)
- Incl. two stainless steel countersunk screws and self-cutting threaded bushes

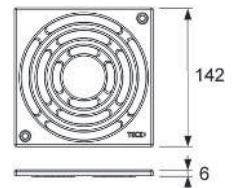

Order No.	DU 1
3665001	1 pc.

TECEdrainpoint S design grate stainless steel, 100 mm

Design grate TECEdrainpoint S 100 x 100 mm made of drawn stainless steel, material 1.4301 (304).

- Dimensions = 100 x 100 mm (outer dimensions)
- Polished surface
- Load class K3 (load up to 300 kg)

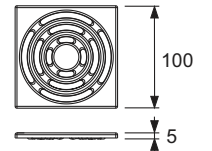

Order No.	DU 1
3665002	1 pc.

TECEdrainpoint S design grate stainless steel, 150 mm

Design grate TECEdrainpoint S 142 x 142 mm made of drawn stainless steel, material 1.4301 (304).

- Dimensions = 142 x 142 mm (outer dimensions)
- Polished surface
- Load class K3 (load up to 300 kg)

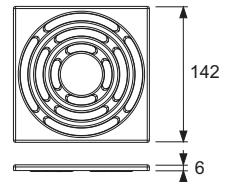

Order No.	DU 1
3665003	1 pc.

TECEdrainpoint S – Grates

TECEdrainpoint S design grate "quadratum" stainless steel, 100 mm

Design grate "quadratum" TECEdrainpoint S 100 x 100 mm, made of stainless steel, material 1.4301 (304).

- Dimensions = 100 x 100 mm (outer dimensions)
- Polished surface
- Load class L15 (load up to 1500 kg)

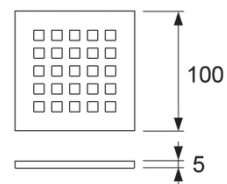
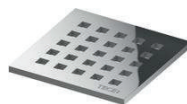

Order No.	DU 1
3665006	1 pc.

TECEdrainpoint S design grate "quadratum" stainless steel, 150 mm

Design grate "quadratum" TECEdrainpoint S 142 x 142 mm, made of stainless steel, material 1.4301 (304).

- Dimensions = 142 x 142 mm (outer dimensions)
- Polished surface
- Load class L15 (load up to 1500 kg)

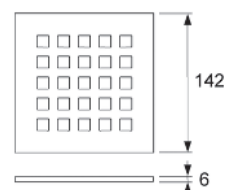
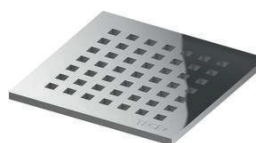

Order No.	DU 1
3665009	1 pc.

TECEdrainpoint S fire protection set FireStop EI 120 DN 50

Fire protection set for direct installation at the drain. TECEdrainpoint S DN 50 drain vertical for highly fire resistant partitioning of ceiling bushings in solid ceilings for up to 120 minutes. Classification in accordance with DIN EN 13501 for fire resistance class EI 120, European technical approval (ETA-11/0437).

Set consists of fire protection sleeve, 2 cross-recessed screws, identification plate and 150 mm DN 50 PP-HT pipe to DIN EN 1451.

Required core drill hole:

Diameter 120 mm (min = 119 mm, max = 123 mm)

Application area: solid ceilings from 150-325 mm ceiling thickness

No grouting or filling of the gap is necessary.

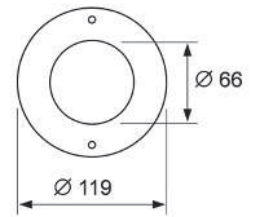

Order No.	DU 1
3690050	1 pc.

TECEdrainpoint S fire protection sleeve DN 70/DN 100

Fire protection sleeve for assembly under the ceiling, using vertical TECEdrainpoint S floor drains DN 70 and DN 100 together with a PP-HT drain pipe in accordance with EN 1451. For highly fire resistant partitioning of the ceiling bushing in solid ceilings for up to 120 minutes.

Required core drill hole:

- DN 70: Diameter 122 mm
- DN 100: Diameter 132 mm

Application area:

solid ceilings \geq 200 mm ceiling thickness

No grouting or filling of the gap is necessary.

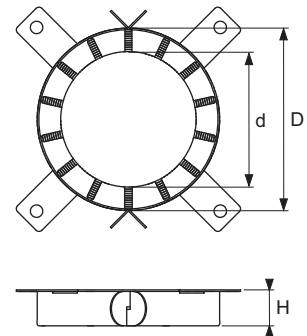

Version	D	d	H	Order No.	DU 1	DU 2
DN 70	132 mm	94 mm	26,6 mm	3690070	1 pc.	10 pc.
DN 100	155 mm	114 mm	26,6 mm	3690100	1 pc.	10 pc.

TECEdrainpoint S Seal System sealing sleeve for composite seals*

Seal System sealing sleeve for the execution of an independently tested connection of TECEdrainpoint S drains to the composite seal.

Consisting of:

- PP fleece (top and underside) and inner waterproof PE foil
- Dimensions = 480 x 480 mm

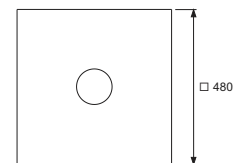
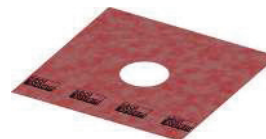

Order No.	DU 1
3690004	1 pc.



TECEdrainpoint S – Accessories

TECEdrainpoint S compression ring set stainless steel

Compression sealing ring set for TECEdrainpoint S drains to create clamped flange connections.

Consisting of:

- Compression ring made of stainless steel, material 1.4301 (304) with pre-drilled hole circle
- Sealing ring made of cellular rubber
- Six stainless steel screws



Order No.	DU 1
3690003	1 pc.

TECEdrainpoint S cut-to-size sealing foil EPDM for clamped flange connections

Sealing sleeve for TECEdrainpoint S drains, for joining bitumen membrane sheets, polymer bitumen membrane sheets or EPDM sealing strips using hot-air welding or full-area welding. The sealing sleeve is fixed on the universal flange with the compression ring set.

- Material: EPDM with glass cloth reinforcement, underside with polymer-modified bitumen layer and fine quartz coating
- Dimensions = 500 x 500 mm
- Material thickness = 3.1 mm
- Manufacturer: Phoenix Restrix MB

Please order separately:

- Compression ring set (Order No. 3690003)

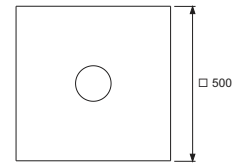
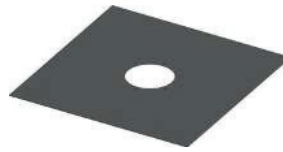

Order No.	DU 1
3690006	1 pc.

TECEdrainpoint S membrane odour trap

Odour trap for TECEdrainpoint S drains made of plastic (PP) with inner sealing lip membrane as protection against evaporation, barrier against odours and vermin, water seal and sealing lip membrane provide two-stage trap effect. Suitable to retrofit to all TECEdrainpoint S floor drains

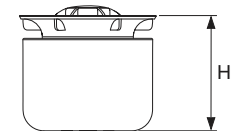

Version	H	Order No.	DU 1
For drain DN 50 extra-flat	50 mm	3695002	1 pc.
For drains DN 50 standard and vertical and DN 70	83 mm	3695005	1 pc.
For drains DN 100	117 mm	3695006	1 pc.

TECEdrainpoint S hair trap

Hair trap made of plastic, for insertion in the TECEdrainpoint S drain.



Order No.	DU 1	DU 2
3690005	1 pc.	100 pc.

TECEdrainpoint S assembly feet, sound-insulated

Assembly feet for TECEdrainpoint S drains with universal flange to make it easy to adjust height and fix in position during the bare-wall installation stage.

Adjustment range lower edge of feet to the upper edge of universal flange: 64-165 mm

Consisting of 4 assembly feet incl. sound-proofing element and mounting material



Order No.	DU 1	DU 2
3690007	1 set	10 set

TECE PP-HT adapter on PVC drain pipes

Adapter to connect TECEdrainline and TECEdrainpoint S drains to PVC waste water pipes.



Dimension	Order No.	DU 1	DU 2	DU 3
DN 40/DN 40	3690000	1 pc.	70 pc.	1120 pc.
DN 50/DN 40	3690001	1 pc.	70 pc.	1120 pc.
DN 50/DN 50	3690002	1 pc.	70 pc.	1120 pc.

TECE adapter DN 50/2"

Adapter to connect TECEdrainline, TECEdrainpoint S and TECEdrainprofile drains to 2" PVC waste water pipes in accordance with BS5255.



Order No.	DU 1	DU 2
669012	1 pc.	10 pc.

Drainbase sound insulation mat for TECEdrainprofile, TECEdrainline and TECEdrainpoint S

Sound insulation mat for fitting under floating screed in the area of floor-level showers or throughout the bathroom. To reduce plumbing noises and impact sounds and for impact sound insulation for renovations and new buildings. Installation noise level with normal shower setting: 22 dB(A) with shower channel TECEdrainline. Made from recycled high-tensile rubber granules bound with PUR elastomer. Meets enhanced sound insulation requirements to DIN 4109, issued 2001-01 and the highest sound protection level SSt III to VDI 4100, issued 2012-10 (sound test verification available from Fraunhofer IBP on request).

- Form of delivery: 1.25 m x 1.25 m x 6 mm
- Fire class: B2 (DIN 4102)
- Thermal resistance: 0.05 (m²K)/W
- Compression at 15 t/m²: 0.6 mm
- Impact sound reduction: ΔL_w = 20 dB(A) (with 50 mm screed)



Order No.	DU 1	DU 2
660001	1 pc.	16 pc.

TECEdrainpoint S – Accessories

Drainbase sound insulation mat (roll) for TECEdrainprofile, TECEdrainline and TECEdrainpoint S

Sound insulation mat for fitting under floating screed in the area of floor-level showers or throughout the bathroom. To reduce plumbing noises and provide impact sound insulation for renovations and new buildings.

Made from recycled high-tensile rubber granules bound with PUR elastomer. Meets enhanced sound insulation requirements for installation noise level according to DIN 4109, issued 2001-01 and the highest sound protection level SSt III according to VDI 4100, issued 2012-10 (sound test verification available from Fraunhofer IBP on request).

- Form of delivery: 8.0 m x 1.25 m x 6 mm (roll, approx. 50 kg)
- Fire class: B2 (DIN 4102)
- Thermal resistance: 0.05 (m²K)/W
- Compression at 15 t/m²: 0.6 mm
- Impact noise reduction: $\Delta L_w = 20$ dB(A) (with 50 mm screed)



Order No.

660002

DU 1

8 m

3601050 – TECEdrainpoint S 50 drain set extra-flat

3601100 – TECEdrainpoint S 110 drain set extra-flat with Seal System universal flange

3601102 – TECEdrainpoint S 112 drain set extra-flat with Seal System universal flange and stainless steel grate frame

Pos.	Order No.	Designation	DU 1
1	3695000	Odour trap superflat made of PP for horizontal outlets DN 50 superflat, height 50 mm	1 pc.
2	3695003	O-ring seal for drain top with 110 mm	1 pc.

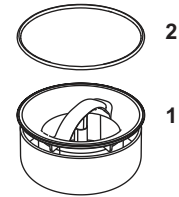

3601200 – TECEdrainpoint S 120 drain set standard with Seal System universal flange

3601202 – TECEdrainpoint S 122 drain set standard with Seal System universal flange and stainless steel grate frame

3601300 – TECEdrainpoint S 130 drain set vertical with Seal System universal flange

Pos.	Order No.	Designation	DU 1
1	3695001	Odour trap standard made of PP for horizontal and vertical outlets DN 50 standard and DN 70, height 83 mm	1 pc.
2	3695003	O-ring seal for drain top with 110 mm	1 pc.

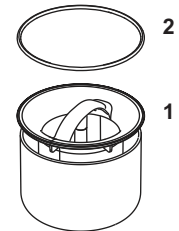

3601400 – TECEdrainpoint S drain DN 50 extra-flat with Seal System universal flange

3601401 – TECEdrainpoint S drain DN 50 terrace with Seal System universal flange

Pos.	Order No.	Designation	DU 1
1	3695000	Odour trap superflat made of PP for horizontal outlets DN 50 superflat, height 50 mm	1 pc.

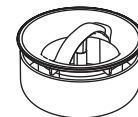

3601500 – TECEdrainpoint S drain DN 50 standard with Seal System universal flange

3601600 – TECEdrainpoint S drain DN 50 vertical with Seal System universal flange

3603500 – TECEdrainpoint S drain DN 70 with Seal System universal flange

3603600 – TECEdrainpoint S drain DN 70 vertical with Seal System universal flange

Pos.	Order No.	Designation	DU 1
1	3695001	Odour trap standard made of PP for horizontal and vertical outlets DN 50 standard and DN 70, height 83 mm	1 pc.



3607500 – TECEdrainpoint S drain DN 100 with Seal System universal flange

3607600 – TECEdrainpoint S drain DN 100 vertical with Seal System universal flange

Pos.	Order No.	Designation	DU 1
1	3695004	Odour trap DIN100, height 117 mm	1 pc.

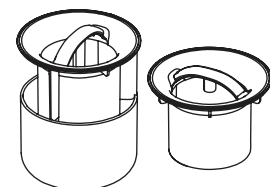

TECEdrainpoint S – Spare parts

- 3660011 – TECEdrainpoint S grate frame stainless steel, 150 mm, design "plate"
- 3660001 – TECEdrainpoint S grate frame plastic, 100 mm, incl. design grate
- 3660002 – TECEdrainpoint S grate frame stainless steel, 100 mm, incl. design grate
- 3660009 – TECEdrainpoint S grate frame stainless steel, 100 mm, incl. design grate, screw-down
- 3660003 – TECEdrainpoint S grate frame plastic, 150 mm, incl. design grate
- 3660004 – TECEdrainpoint S grate frame stainless steel, 150 mm, incl. design grate
- 3660010 – TECEdrainpoint S grate frame stainless steel, 150 mm, incl. design grate, screw-down
- 3660007 – TECEdrainpoint S grate frame stainless steel, 100 mm, incl. design grate "quadratum"
- 3660008 – TECEdrainpoint S grate frame stainless steel, 150 mm, incl. design grate "quadratum"
- 3660005 – TECEdrainpoint S raising element with Seal System universal flange
- 3660006 – TECEdrainpoint S extension
- 3660019 – TECEdrainpoint S grate frame plastic, 150 mm, without grate



Pos.	Order No.	Designation	DU 1
1	3695003	O-ring seal for drain top with 110 mm	1 pc.

Drainage capacity TECEdrainpoint S

(Specified in l/s, according to DIN EN 1253)

Drain Designation (Order number)	Drain top and cover (order number)	Minimum height of drain top (1)		Maximum height of drain top (2)	
		Water level above grate			
		10 mm	20 mm	10 mm	20 mm
DN 50 extra-flat (3601400)	Top with design grate, 100 mm (3660001, 3660002, 3660009)	0.52	0.61	0.69	1.12
	Top with design grate “quadratum”, 100 mm (3660007)	0.44	0.69	0.53	0.85
	Tileable top “frameless”, 100 mm (3660016 + 3660006)	0.49	0.55	0.61	1.00
	Top with tileable frame base “plate”, 150 mm (3660011)	0.64	0.70	0.98	1.04
DN 50 standard (3601500)	Top with design grate, 100 mm (3660001, 3660002, 3660009)	0.52	0.89	0.64	1.35
	Top with design grate “quadratum”, 100 mm (3660007)	0.42	0.81	0.64	0.93
	Tileable top “frameless”, 100 mm (3660016 + 3660006)	0.45	0.75	0.79	1.07
	Top with tileable frame base “plate”, 150 mm (3660011)	0.91	0.98	1.33	1.46
DN 50 vertical (3601600)	Top with design grate, 100 mm (3660001, 3660002, 3660009)	0.64	1.36	0.70	1.56
	Top with design grate “quadratum”, 100 mm (3660007)	0.56	1.02	0.67	1.46
	Tileable top “frameless”, 100 mm (3660016 + 3660006)	0.62	0.96	0.89	1.48
	Top with tileable frame base “plate”, 150 mm (3660011)	1.33	1.41	1.63	1.69
DN 50 terrace (3601401)	Top with design grate, 100 mm (3660001, 3660002, 3660009)	0,66	1,22	0,50	1,51
	Top with design grate “quadratum”, 100 mm (3660007)	0,48	0,89	0,56	1,53
	Tileable top “frameless”, 100 mm (3660016 + 3660006)	0,71	0,97	0,81	1,07
	Top with tileable frame base “plate”, 150 mm (3660011)	0,97	1,46	0,86	1,27
DN 70 horizontal (3603500)	Top with design grate, 150 mm (3660003, 3660004, 3660010)	0.62	1.22	0.87	1.74
	Top with design grate “quadratum”, 150 mm (3660008)	0.76	1.13	0.78	1.54
	Tileable top “frameless”, 100 mm (3660016 + 3660006)	0.64	0.84	0.97	1.54
	Top with tileable frame base “plate”, 150 mm (3660011)	1.19	1.29	1.50	1.72
DN 70 vertical (3603600)	Top with design grate, 150 mm (3660003, 3660004, 3660010)	0.47	1.81	0.63	1.84
	Top with design grate “quadratum”, 150 mm (3660008)	0.79	1.67	0.68	1.99
	Tileable top “frameless”, 100 mm (3660016 + 3660006)	0.64	0.85	0.80	2.18
	Top with tileable frame base “plate”, 150 mm (3660011)	1.62	1.97	2.24	2.42
DN 100 horizontal (3607500)	Top with design grate, 150 mm (3660003, 3660004, 3660010)	0.90	1.61	0.86	2.03
	Top with design grate “quadratum”, 150 mm (3660008)	0.77	1.48	0.79	1.98
	Tileable top “frameless”, 100 mm (3660016 + 3660006)	0.46	1.12	0.58	1.81
	Top with tileable frame base “plate”, 150 mm (3660011)	1.36	1.48	1.60	2.06
DN 100 vertical (3607600)	Top with design grate, 150 mm (3660003, 3660004, 3660010)	0.76	1.42	0.80	2.10
	Top with design grate “quadratum”, 150 mm (3660008)	0.70	1.33	0.74	2.13
	Tileable top “frameless”, 100 mm (3660016 + 3660006)	0.76	1.06	0.59	1.86
	Top with tileable frame base “plate”, 150 mm (3660011)	1.22	1.36	1.72	2.20

